

GAS EQUIPMENT

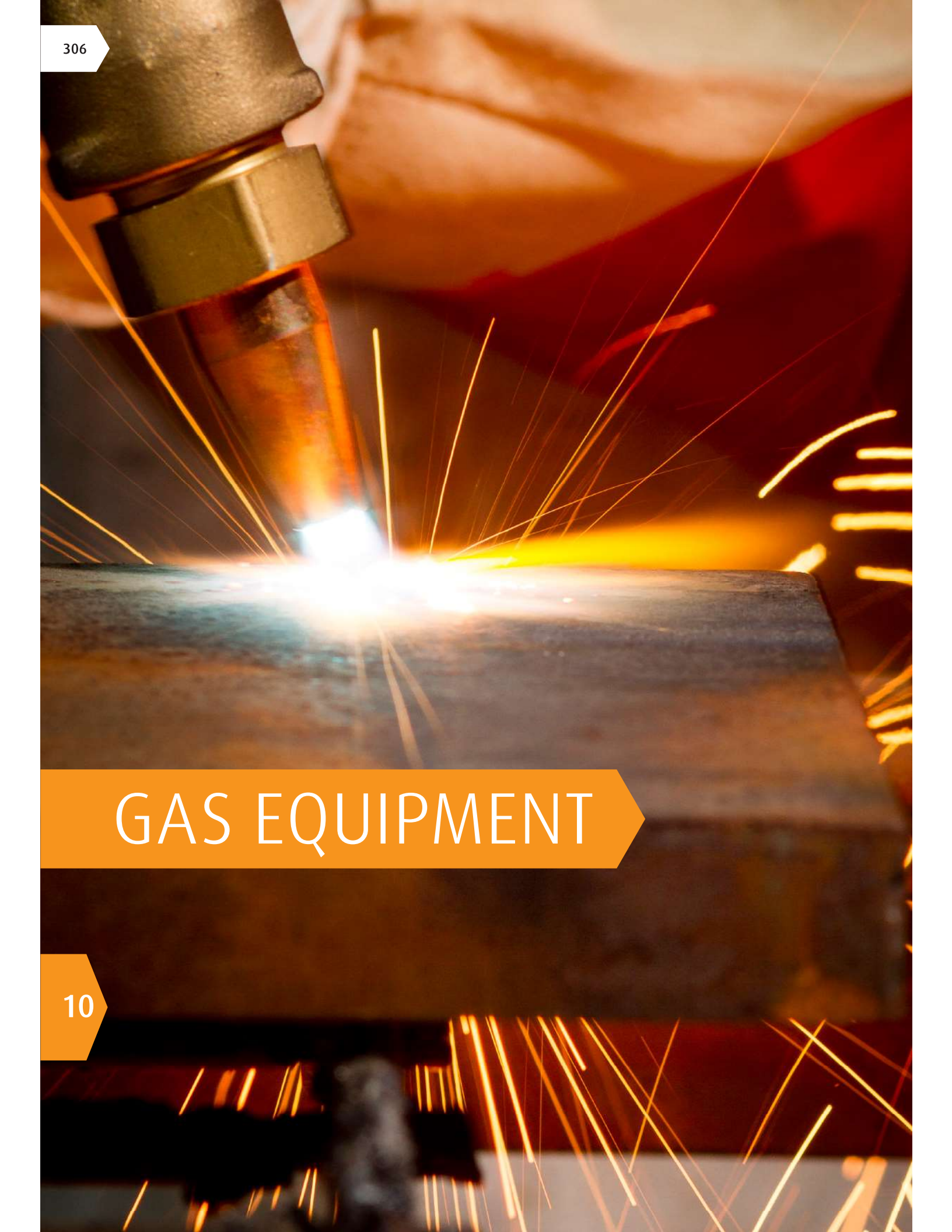

Section 10 - Gas Equipment	306
Afrox Range	308
Oxy-Fuel Cutting, Welding & Heating Processes	308
Industrial Regulators & Flowmeters	315
Saffire® 916 Multi-Stage Regulators	324
Regulator Spares, Fittings & Attachments	325
Torches & Attachments	327
Nozzles	336
Flashback Arrestors & Quick Release Couplings	343
Gas Hoses & Fittings	348
Gas Equipment Accessories	351
PortaPak®	353
Gas Welding & Cutting Outfits	355
Sievert® Equipment	357
Gas Cutting Machines	362
IBEDA	365
Flashback Arrestors & Quick Release Couplings	365
Transarc® Gas Equipment	370

AFROX RANGE

Oxy-Fuel Cutting, Welding & Heating Processes

Gas Welding

Combustion can only take place if three conditions are satisfied.

There must be a fuel. A fuel is a material that burns or combusts with oxygen to release energy. The hot gases produced by combustion form a flame. Most, but not all, fuels are hydrocarbons. Oxygen must be present. Oxygen is a chemical element with which most chemical compounds will combine in an exothermic reaction.

Ignition is required for the fuel/oxidant mixture to ignite and produce a flame. The source of ignition may be a pilot flame, an electrical spark, a hot spot or a sudden pressure change. In the process of combustion, ignition causes a fuel to react with oxygen.

The products of complete combustion, in the case of hydrocarbon fuels, are oxides such as carbon dioxide and water, and a large amount of energy in the form of heat and light.

When oxygen and a fuel gas are burned together at the end of a nozzle, a flame is created and it is this flame that is used to melt both the parent and filler material. Of all the fuel gases available, acetylene is the most widely used because of its higher flame temperature and the ease at which the flame can be set.

When equal quantities of acetylene and oxygen are burned, a neutral flame is created and this has two visibly distinct zones within it. In actual fact, there are more than two zones within a neutral flame – there are four.

Looking from the nozzle, the first zone is an unburned mixture of oxygen and acetylene. No combustion takes place here because the gases are effectively at room temperature and there is no source of heat.

On the edge of this inner zone is a bright blue-white stationary combustion zone where burning takes place. The reaction within this area can be defined by the equation:

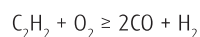

The outside of this zone is the hottest point of the flame.

These two zones form what is called the primary zone or primary cone of the flame.

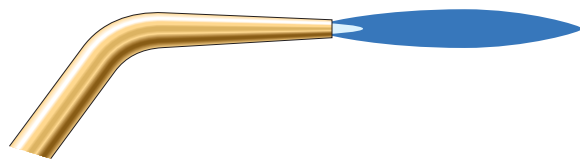

Schematic of the gas welding flame

Further out from the primary zone is the reducing zone. Very little combustion takes place in this zone, as most of the

oxygen available was consumed in the previous zone. The outside zone is where the remaining by-products of the initial combustion burn with oxygen from the atmosphere.

Here the reactions are:



These outside two zones form what is termed the secondary zone or outer envelope.

Flame Types

Although the neutral flame is the most commonly used for gas welding, two other flame types – oxidising flame and carburising flame – are used for different applications.

Neutral Flame

In the neutral flame, the primary zone is sharp and clearly defined.



The neutral flame is used for gas welding:

- Carbon and alloy steels
- Stainless steel
- Cast iron
- Copper.

Oxidising Flame

As the name suggests, in an oxidising flame an excess of oxygen is present. This produces a much shorter, brighter secondary zone. The oxidising flame is also noisier than the other two flame types.



The oxidising flame is primarily used for gas welding brass.

Carburising Flame

The carburising flame is created by having a small excess amount of acetylene present in the flame. This flame is clearly distinguished by a small 'feather' of acetylene at the end of the primary zone.



The excess of acetylene in the flame adds carbon into the weld pool and is used predominantly for hardfacing applications.

Application

The application of gas welding is wide and various, both in terms of the thickness range and the materials that can be welded with it. It can also be used to weld in all positions as long as the operator has the skill required to carry out the task.

The industries that use gas welding are varied. The relatively low cost equipment and its flexibility mean that every engineering workshop is likely to have a system on site. Of these systems, oxy-acetylene is by far the most common because it is the only gas combination that can be used to weld all materials.

Gas welding has also become a favourite with the home DIY hobbyist, again because of its flexibility.

The Oxy-Fuel Welding Process

Welding

Welding is using a flame to melt the plate and add filler.

Welding (fusion welding) takes place when a flame is used to heat the edges of the joint to melting temperature. When the metal is in a molten state, the edges flow together. The addition of the welding rod may be required, depending on the type of joint being welded.

Braze Welding

Brazing and braze welding take place at temperatures above 450°C, but below the melting point of the base metal.

Braze welding happens when the edges of the joint to be welded are heated sufficiently to melt the braze welding rod, which then flows onto the joint edges, producing a fillet in the joint. The parent metal does not melt. The process is one of adhesion.

An advantage of braze welding is reduced distortion because of the lower temperatures.

The filler material is an alloy of copper and zinc and may also contain other elements such as silicon, nickel or manganese.

A flux, either coated on or contained within the rod, must chemically clean the surface of the parent metal during heating.

The edges of the joint to be welded are heated sufficiently to melt the braze welding rod which then flows on to the joint edges. The parent metal does not melt.

Comparisons

Advantages of braze welding:

- Less distortion because of lower heat input
- Faster welding speeds because of lower heat input.

Disadvantages

- Weakness of joint at high temperatures

- Mismatch of colour between parent metal and the bronze welded deposit.

Braze welded joints

- Fillet joints
- Lap joint
- Butt joint
- No fusion of the joint edges
- Pronounced build-up of the filler metal.

Brazing

Brazing is the adhesion of one plate to another without melting at temperatures above 450°C but below the melting point of the base metal. The filler material to form the union is non-ferrous.

Features of brazing

- Filler metal in a thin film (0,0254 – 0,0085 mm) between two or more tightly fitted pieces of base metal
- Often referred to as silver brazing or silver soldering
- Fast metal joining is achieved because:
 - Brazing rod has the lowest achievable melting point, which can lead to capillary action
 - Whole joint is raised to the correct temperature (in contrast with localised heat applied in welding)
 - Brazing rod flows by capillary action along joint edges and through to the reverse side of the joint.

Braze joints

- Fillet joints
- Lap joints
- Butt joints – not suitable for brazing.

Fluxes in brazing

Fluxes clean the metal surface.

When fluxes are used to clean the surface chemically, the parent metal does not melt. The cleaning permits a good bond between the parent metal and the brazing welding rod when brazing:

- Mild steel
- Stainless steel
- Cast iron
- Copper.

Removal of fluxes

Removal of fluxes after brazing is important when using aluminium, as the flux residues are very corrosive to aluminium.

Flux not needed

When using the copper phosphor brazing rod to braze with copper, a flux is not needed.

Soldering

Soldering is also adhesion at a lower temperature. Filler metal or solder alloy with a melting temperature of less than 450°C

is used. The filler metal wets the parent metal, spreads, makes contact with the joint opening and is drawn into the joint by capillary action.

Filler metals in soldering

- Soldering is another type of adhesion process
- Filler metal or solder alloy with a melting temperature of <math><450^{\circ}\text{C}</math> is used
- Binary tin-lead alloys are most commonly used
- Some tin-lead filler metals contain a little antimony (up to 3%) to improve the mechanical properties of the soldered joints
- The filler metal wets the parent metal, spreads, makes contact with the joint opening and is drawn into the joint by capillary action.

Fluxes in soldering

- Fluxes consist of either:
 - Various forms of inorganic weak acid solutions and salts
 - Resins dissolved in organic solvents
- Acid and salt fluxes are corrosive and residues must be removed after soldering
- Resin fluxes are not corrosive.

Function of fluxes in soldering

The function of the flux is to prevent, to dissolve or to remove oxide films and other contaminants. It is NOT a function of the flux to clean dirt from the base metal. Pre-cleaning of the joint faces must be done.

Types of joints

The lap joint is best used because it offers maximum strength. The solder alloy must completely fill the gap to prevent moisture getting in and causing corrosion.

Only the correct clearance between the joint faces will enable the solder to enter the joint by capillary action. The filler alloy must be selected for joint gap, as those with a narrow melting range tend to rise higher than those with a wide melting range.

Oxy-Fuel Cutting



Overview

Flame cutting, oxy-fuel cutting, fuel gas cutting and oxygen cutting are terms that are generally used for the same process. Of all the terms used, oxygen cutting best describes how the process operates.

In oxygen cutting, the metal is heated to its ignition temperature and then a jet of pure oxygen is added, which reacts with the metal creating the cut.

The process was originally developed in the beginning of the 20th century and, while the basics haven't really changed over the years, there have been significant improvements in equipment design. The process is very versatile and can be used both manually or built as a machine, with either single or multiple torches for higher operating efficiencies.

Although a worker can be trained in a short time to make acceptable cuts with the process, considerable skill is necessary to produce cut surfaces suitable for welding. The equipment is also relatively cheap and portable.

Though the equipment for mechanised cutting is more expensive, there is still a high level of skill required by the operator. As profile cutting machines become more programme-controlled, a good understanding of computers is also becoming advantageous.

How It Works

The oxygen cutting process can be considered as a combination of two distinct and separate processes. First the material to be cut must have its temperature increased to the point where it will burn in the presence of oxygen. This is called the ignition temperature of the steel. In oxygen cutting of steel, this is achieved by preheating a localised area until the metal reaches a bright cherry red heat at about $870 - 900^{\circ}\text{C}$.

- 1 Cutting oxygen nozzle
- 2 Heated steel
- 3 Cutting oxygen
- 4 Direction of cut
- 5 Steel

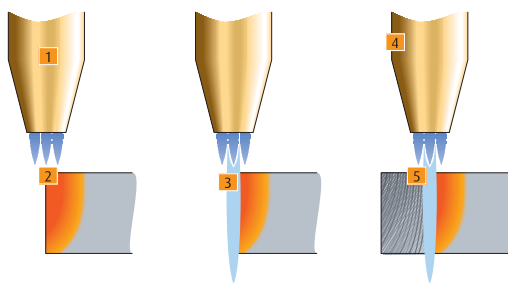

Schematic of the oxygen cutting process

At this point, a jet of cold oxygen is passed through the centre of the nozzle onto the red-hot steel. This causes a chemical reaction between the steel and the oxygen, generating more heat and melting the steel. This is called an exothermic reaction.

The steel immediately below the oxygen jet is converted to a metal oxide or slag, and is blown away by the jet. If the oxygen stream isn't powerful enough, or if the cutting speed is too quick, the slag will solidify in the cut, and a cut will not be achieved.

As the torch begins to move, more steel is preheated and the oxygen jet burns more of the steel, creating the cut.

Preheat Flame

The preheat flame is formed by the combustion of the pre-heat oxygen and the fuel gas combined either in the torch or the nozzle. It serves three purposes:

- It raises the metal to its ignition temperature
- It counters heat losses due to conduction into the bulk metal
- It shields the cutting oxygen from the effects of entrainment from the surrounding atmosphere.

Although the ignition temperature depends upon the material being cut, the choice of fuel gas has an effect on how quickly the flame will raise the material to the ignition temperature. The higher flame temperature of oxy-acetylene (3,160°C compared to 2,828°C for oxy-propane) will mean that if oxy-acetylene is used, then cutting would commence sooner than for oxy-propane. The thicker the material, the more pronounced this effect becomes.

As cutting begins, it is theoretically possible to turn off the preheat flame as the reaction of the oxygen and steel is exothermic, generating heat. In reality, heat is conducted away from the cut face by the material and the preheat flame is needed to counteract this effect.

The purity of the cutting oxygen stream is very important and the preheat flame acts as a barrier, keeping out the nitrogen in the atmosphere that would react with the cutting oxygen, producing oxides of nitrogen. Should these oxides be produced, they would reduce the cutting speeds and increase oxygen consumption.

Heating

Flame Heating

Flame heating is a method of raising the temperature of components that are usually large and the flame heating process is usually associated with the welding process.

Fabrications may need preheat, interpass temperature control and post heat treatment to follow the welding procedures of critical components and structures or flame heating may be required to simply remove moisture from a weld joint prior to welding.

Flame heating is also used to locally heat components prior to another process such as bending or forming being carried out. Specialised equipment is manufactured for all types of heating applications and may range from a specialist heating equipment and nozzle to an adaptor for a welding or cutting torch.

The process is mobile and all positional, making it ideal for use on large components or structures.

Fuel gas processes, by their nature, use flammable, potentially explosive gases, often in conjunction with oxygen. The gases may be supplied in and used from pressurised gas cylinders and mixed in welding or cutting torches. The main hazards, therefore, are from naked flames, fire and explosion.

Fault Finding Reference Guide

Symptom	Cause	Resolution
A. No gas flows when torch valves are open	1. No gas in cylinder	1. Check contents gauges of both cylinders and refill appropriate cylinder
	2. Cylinder valve not open	2. Crack cylinder valve slowly, open another 1/2 to 1 full turn
	3. Regulator valve not open	3. Set correct pressures on regulator before lighting up
	4. Incorrect flashback arrestors	4. Torch mount arrestors must be fitted on the torch side only. Regulator mount arrestors must be fitted to regulator side only
	5. Flashback arrestors blocked	5. Check inlet filters and replace if necessary
	6. Hoses blocked	6. Blow out hoses with nitrogen or replace hoses if necessary
	7. Nozzle blocked	7. Clean nozzle with approved nozzle cleaner or replace nozzle if necessary
B. Gas won't ignite when torch is opened	1. Oxygen torch valve is open	1. Acetylene is the fuel gas and must be ignited first, with oxygen fully shut
C. Flashbacks occur when acetylene is ignited	1. Pressure not correct for nozzle in use	1. Consult nozzle data chart for the correct pressures for the appropriate nozzles
	2. Flashback occurs	2. Purge each hose separately before use for approximately 2 seconds per 6 m length of hose
D. Flame around nozzle nut when torch is ignited	1. Nozzle nut not tightened	1. Tighten nozzle nut until flame is extinguished
	2. Torch head seat damaged	2. Exchange torch for an Afrox Servex replacement
	3. Nozzle seat damaged	3. Replace nozzles
E. 'Popping' noise heard from torch head	1. Gases mixing in torch head causing small sustained flashbacks	1. Check the nozzle and torch seats, replace if damaged. If not damaged, tighten the nozzle nut 2. Clean nozzle with approved nozzle cleaner to avoid damage
F. Nozzle not cutting properly or effectively	1. Incorrect nozzle for size and type of material being used	1. Refer to nozzle data chart or Afrox experts for pressure setting and flow rates

Symptom	Cause	Resolution
G. Cutting lever does not produce a cutting stream	<ol style="list-style-type: none"> 1. Incorrect operation procedure (Type 2 torch and Universal[®]) 2. Oxygen pressure not high enough 3. Torch internally damaged 	<ol style="list-style-type: none"> 1. Open oxygen control valve on shank fully. Control preheat flame by oxygen valve on attachment 2. Consult nozzle data chart 3. Trade in torch for an Afrox Servex replacement
H. 'Garlic' or 'fishy' smell occurs when torch is in use	<ol style="list-style-type: none"> 1. Fuel gas (DA/LPG) leaking 2. 'Garlic' smell – Acetylene leaking from gas set 3. 'Fishy' smell – LPG leaking from gas set 	<ol style="list-style-type: none"> 1. Test for leaks using Safetest leak detection fluid NB: Oxygen is odourless, colourless and is dangerous when excessive amounts are vented into the atmosphere. Check for leaks regularly on both lines
I. Loud explosion occurs when cutting, welding or heating	<ol style="list-style-type: none"> 1. Flashback has occurred 	<ol style="list-style-type: none"> 1. Flashback arrestors must be used to stop back-feeding of gases and quenching of flames
J. Hoses burst after loud explosion	<ol style="list-style-type: none"> 1. Flashback has occurred 	<ol style="list-style-type: none"> 1. Flashback arrestors must be used to stop back-feeding of gases and quenching of flames
K. Acetylene cylinder hot	<ol style="list-style-type: none"> 1. Cylinder burning inside 	<ol style="list-style-type: none"> 1. Close cylinder valve 2. Evacuate area immediately 3. Hose down with water from a safe distance if possible 4. Call supplier (do not use cylinder again)
L. Acetylene cylinder hot. Paint peeling off or cylinder jumping around	<ol style="list-style-type: none"> 1. Cylinder burning inside and ready to explode 	<ol style="list-style-type: none"> 1. All persons evacuate immediately
M. Cylinder/s explode/s	Ensure that your cylinders are always kept in good condition and ensure that flashback arrestors are connected to both the torch and regulator. Ensure that correct nozzles are fitted in accordance with the fuel gas being used as fuel gas/oxygen mixtures vary when using oxy/acetylene and oxy/LPG	

Standards

All gas equipment must comply to the following local/international standards:

- Regulators: ISO 2503
- Torches: ISO 5172
- Hoses: ISO 3821 for oxygen, acetylene & inert hose
SANS 1156-2 for LPG
- Hose connections: SANS 3253
- Flashback arrestors: EN 730-1
- Hose assemblies: SANS 8207
- Health & Safety Code of Practice: SANS 10238.

The following guidelines, standards and products are available to assist you and your business:

- ISO approved regulators fitted with encapsulated valves, fit-for-purpose and conforms to ISO 2503 with optional gauge guard, if required
- EN approved regulator mounted flashback arrestors consisting of a temperature activated cut-off valve, flame arrestor, non-return valve and pressure activated cut-off valve on both oxygen and acetylene lines
- Correct length of hoses, fit-for-purpose and ISO approved
- Approved hose connections in accordance with SANS 8207 which include 'O' clips fitted with correct crimping tool
- Suitable hose holders or parallel hose clips fitted in such a way that hoses can be separated easily and do not have any sharp edges
- Flashback arrestors must be fitted to both the regulator and torch
- Approved torches compliant to ISO 5172
- Nozzles: Quality tested for leaks across the seats and quality of performance
- Quality nozzle cleaner to ensure good and consistent quality performing nozzle
- Before light-up, equipment must first be purged. Then leak tested with the correct leak detection solution such as Afrox Safetest (Item Number W012045) which is oil-free. No soapy solutions shall be used on gas equipment
- Only a spark lighter such as the Afrox triple flint lighter (Item Number W012621) shall be used to ignite the gas flowing from the nozzle. Under no circumstances must an open flame be used
- Under no circumstances shall PTFE tape be used on oxy-fuel equipment. Manufacturer uses special oil-free type tape on gauges and for example if spare parts are required for maintenance, equipment will be provided by manufacturer with correct tape attached
- Trolleys to transport oxygen/acetylene cylinders shall be in good working condition. Refrain from using home-made trolleys.
- Correct PPE to be worn at all times
- Wall-mounted posters on light-up and shutdown

procedures and other posters and data sheets provided by manufacturer to be visible at all times at every station

- Risk assessments to be conducted on a regular basis. Level to be determined by management
- Flashback arrestors shall be tested or replaced bi-annually. Afrox flashback arrestors can be tested with a WITT test panel (Item Number W012212)
- Never use oil or grease on any gas equipment
- Operators should be trained on the safe use and handling of gas and gas equipment before working on gas equipment
- Training must include product training, correct fitment of equipment and correct safe operating practices (eg. correct light-up and shutdown procedure)
- Never repair gas equipment, although maintenance (eg. replacing a faulty gauge on a regulator) can be done by a qualified operator.

Industrial Regulators & Flowmeters

Afrox Series 8500 regulators are designed to give a constant, precise delivery of the required pressure of gas without the need for continuous readjustment. This is important in applications where an operator works at a distance from the regulator.

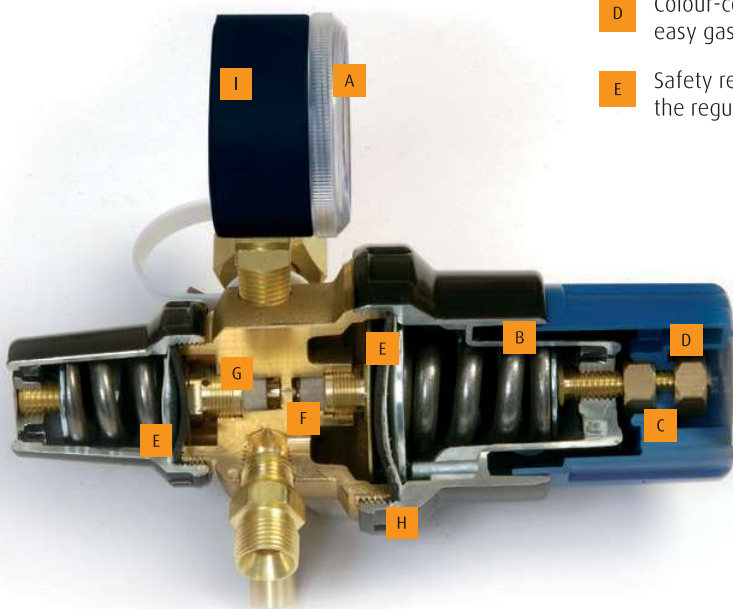

- A** Working pressure gauges on the regulators are marked 'cut', 'weld' and 'heat' for easy setting
- B** Bonnet design protects components from rain and moisture, resulting in longer life and greater durability
- C** Captive knob design prevents over-pressurisation and jamming
- D** Colour-coded control knob for fine pressure control and easy gas identification
- E** Safety relief valves and flexible diaphragm design protects the regulator in the event of over-pressurisation

- F** Dual-filtering system reduces contamination, protecting the high-pressure seat from damage
- G** Dual-encapsulated valve design delivers exceptional pressure stability, superior accuracy and extended life
- H** Forged zinc bonnet for maximum durability and extended life in corrosive environments
- I** Blow-out back for added safety

Regulators

A range of both multi-stage and single-stage regulators are available to suit most applications.

Because of their inherent safety features, multi-stage regulators should always be used as the product of choice. Their flat outlet characteristic, irrespective of changes in cylinder pressure, make them the obvious choice.

All regulators are subject to a rise in outlet pressure as inlet pressure drops. This aspect can be minimised by good design in a single-stage but cannot be eliminated. Multi-stage regulators do not display this characteristic!

As the contents of the cylinder reduces, so the outlet pressure on a single-stage regulator rises.

An inexperienced operator will not know to compensate for this and will continue to operate. This rising pressure can cause one gas to feed back against the other in the system and a flashback could result.

When acetylene is mixed with air or oxygen – in concentrations of as little as 2% or as much as 82% – it will explode if ignited. This means there is a substantial risk of an explosion if backfeeding or mixing takes place.

Afrox's multi-stage regulator does not give rise to this situation due to its design.

Therefore, in the hands of less-skilled operators, multi-stage regulators are the preferred choice. This applies very specifically to the mines where low skill levels are used in very dangerous confines, e.g. underground.

Series 8500 Multi-Stage Regulators

Afrox's Series 8500 multi-stage regulator was designed by an international gas welding and cutting equipment team.

The latest technology and materials have been incorporated in the Afox Series 8500 to maximise the advantages of the tried and tested multi-stage principle.

Two fully encapsulated pressure regulating valves further enhance the safety, quality and durability of the regulator.

As a result, the Afox Series 8500 is the most reliable regulator on the market. It keeps safety at a premium, and losses in productivity to a minimum.

The Afox Series 8500 multi-stage regulator is superior to single-stage regulators because:

- It delivers a constant outlet pressure without the need for adjustment
- It allows for much finer control of the outlet pressure
- It provides longer, trouble-free service
- The regulator operates under much lower stresses because the cylinder pressure is first reduced to an intermediate stage and then to the second stage
- Series 8500 regulators meet the ISO 2503 standard, with the high pressure models being suitable for 30 000 kPa (300 bar) inlet pressures in international applications and 23 000 kPa locally.

An Afox Series 8500 multi-stage regulator remains the professional's choice.

Encapsulated Valves

Afrox has pioneered the development of a fully encapsulated regulator valve whereby the sensitive 'heart' of the device is protected by a sintered metal filter. The complete valve is built with the filter under clean-room conditions, thereby avoiding any chance of foreign particles blocking the valve mechanism.

Encapsulated valves are built into all Afox regulators. All Afox multi-stage regulators have a filter built into the first stage valve mechanism and also use the encapsulated valve design in the second stage. The advantages to the user of these innovations are greater reliability, greater safety and greater efficiency.

Hybrid Regulators

Afrox SMOOTHFLO™ Regulators

The SMOOTHFLO™ hybrid gas pressure regulator incorporating “Dynamic Quadflow Stability Control” (DQSC) represents the highest level of development in the global gas pressure regulator arena. Incorporating several world firsts, the SMOOTHFLO™ combines the best of all regulator characteristics worldwide, with innovative features that take the technology to a new level, making this regulator one of the easiest to use. Developed in-house and embodying the Linde spirit of taking the lead, the new SMOOTHFLO™ gas pressure regulator has an innovative and compact design that achieves impressive levels of performance and safety.

Features

- Break-off inlet stem
- Robust cladding
- Unique lever activation technology
- Embedded pressure gauges
- Piston-embedded safety valve
- Piston driven technology
- All regulators conform to the ISO 2503 standard and are quality tested at full service pressure for superior operator safety and control

Range

SMOOTHFLO™ regulators are currently available for oxygen and acetylene.



Afrox SMOOTHFLO™ Multi-Stage Regulators

Model	Description	Gas Used	Delivery Pressure	Inlet Connection	Outlet Connection	Max Inlet Pressure	Item Number
Acetylene	Acetylene 150 kPa	Acetylene	0 - 150 kPa	5/8" BSP LH	3/8" BSP LH	2 500 kPa	W003137
Oxygen	Oxygen 1 000 kPa	Oxygen	0 - 1 000 kPa	5/8" BSP RH	3/8" BSP RH	20 000 kPa	W003139

Afrox Saffire® Multi-Stage Medium-Heavy Duty Regulators

Afrox Series 8500 multi-stage regulators are the product of choice for the professional, designed for optimum performance in welding, cutting and heating applications and for circumstances where exceptional safety is required. With its best-in-class flows and control, unique safety features and rugged heavy duty design, the Series 8500 is well suited for use in tough industrial and corrosive environments.

The series comprises a full range of products designed specifically for use in applications using oxygen, acetylene, nitrogen, air and inert gases.

Multi-stage high outlet pressure regulators are suited to heavy duty welding, cutting, gouging, superheating and light lancing applications.

Features

- It delivers constant outlet pressure control without the need of adjustment i.e. 'Set-and-Forget'
- Dual, third generation Quadflo encapsulated valves with sintered metal cup filters ensuring improved filtration and higher flow capacity
- It allows for much finer control of the outlet pressure
- It provides longer, trouble-free service
- The regulator operates under lower stresses because the cylinder pressure is first reduced to an intermediate stage and then to the second stage
- All regulators conform to the ISO 2503 standard and are quality tested at full service pressure for superior operator safety and control
- Working pressure gauges are marked 'cut', 'weld' and 'heat' for easy setting
- Manufacturing date stamped on the regulator
- 'Rain protect' bonnet design protecting internal components from rain and moisture.



Afrox Saffire® Multi-Stage Medium-Heavy Duty Regulators

Model	Description	Gas Used	Delivery Pressure	Inlet Connection	Outlet Connection	Max Inlet Pressure	Item Number
S8500 AGM 150 kPa	Multi-stage general purpose pressure regulator with gauges for welding, cutting and heating	Acetylene	0 - 150 kPa	5/8" LH	3/8" LH	2 500 kPa	W003851
S8500 OGM 400 kPa	Multi-stage medium duty regulator with gauges for welding and cutting	Oxygen	0 - 400 kPa	5/8" RH	3/8" RH	30 000 kPa	W003852
S8500 AVM 150 kPa	Multi-stage general purpose regulator for welding and cutting without gauges. Outlet pressure indicated by a visual indicator on the pressure regulating adjusting knob	Acetylene	0 - 150 kPa	5/8" LH	3/8" LH	2 500 kPa	W003853
S8500 OGM 1 000 kPa	Multi-stage pressure regulator with gauges for heavy duty cutting, gouging, superheating and light lancing applications	Oxygen	0 - 1 000 kPa	5/8" RH	3/8" RH	30 000 kPa	W003854
S8500 OVM 1 000 kPa	Multi-stage heavy duty pressure regulator without gauges. Outlet pressure indicated by a visual indicator on the pressure regulating adjusting knob	Oxygen	0 - 1 000 kPa	5/8" RH	3/8" RH	30 000 kPa	W003855
S8500 NGM 1 000 kPa	Multi-stage high outlet pressure nitrogen regulator, with calibrated cylinder contents and outlet pressure gauges	Nitrogen/ Argon	0 - 1 000 kPa	3/4" RH	3/8" RH	30 000kPa	W003856
S8500 HGM 1 000 kPa	Multi-stage high outlet pressure hydrogen regulator, with calibrated cylinder contents and outlet pressure gauges	Hydrogen	0 - 1 000 kPa	5/8" LH	3/8" LH	30 000 kPa	W003857

Please Note: For ultimate safety, always use Afrox approved flashback arrestors.

Afrox Saffire® Series 8000 Single-Stage Medium Duty Regulators

Every Aprox Series 8000 regulator incorporates proven global regulator technology – the unique Aprox encapsulated valve – providing superior performance and extended life. This, together with the heavy duty construction, provides longer trouble-free operation – backed by an exceptional five-year conditional warranty.

With flows comparable to many multi-stage regulators in the market, the broad flow and pressure ranges make this an ideal regulator for welding, cutting and heating applications.

The series comprises a range of versatile regulators designed specifically for use in applications using oxygen, acetylene or nitrogen.

The 400 kPa oxygen regulator is suited for general-purpose welding, heating and cutting up to 100 mm. This regulator provides an adequate pressure to run the whole range of welding nozzles and any of the AHT heating nozzles.

Features

- Every Aprox manufactured single-stage regulator meets the ISO 2503 standard and is tested at full service pressure for superior operator safety and control
- Third generation Quadflo encapsulated valve with sintered metal cup filter ensuring improved filtration and higher flow capacity. Suitable for gas welding, cutting and heating applications
- Working pressure gauges are marked 'cut', 'weld' and 'heat' for easy setting
- Manufacturing date stamped on the regulator
- 'Rain protect' bonnet design protecting internal components from rain and moisture.



Afrox Saffire® Series 8000 Single-Stage Medium Duty Regulators

Model	Description	Gas Type	Delivery Pressure	Inlet Connection	Outlet Connection	Max Inlet Pressure	Item Number
S8000 AGS 150	Single-stage general-purpose regulator for welding, cutting and heating	Acetylene	0 - 150 kPa	5/8" LH	3/8" LH	2 500 kPa	W003801
S8000 OGS 400	Single-stage medium outlet pressure regulator for medium duty welding and cutting	Oxygen	0 - 400 kPa	5/8" RH	3/8" RH	30 000 kPa	W003802

Afrox Saffire® Series 5000 PortaPak® Regulators

The Aprox Saffire® two-gauge single-stage PortaPak® regulators are designed to be used with the portable Aprox PortaPak® outfits in light duty, general-purpose non-continuous welding, cutting and heating applications up to 2-bar oxygen working pressure. They are compact, rugged and portable; ideal for mobile operations. Their flow characteristics and compact design make them ideally suited to jobs on the move where space is a constraint – including plumbing and contract engineering.

Features

- Suitable for light duty cutting and welding applications
- Used in PortaPak® outfits
- All regulators conform to the ISO 2503 standard and are quality tested at full service pressure for superior operator safety and control
- PortaPak® Oxygen 200 regulator includes a safety regulator valve



Afrox Saffire® Series 5000 PortaPak® Regulators

Model	Description	Gas Type	Delivery Pressure	Outlet Connection	Max Inlet Pressure	Item Number
PortaPak® Oxygen 200	Single-stage regulator suitable for light duty welding and cutting applications	Oxygen	0 - 200 kPa	1/4" RH	20 000 kPa	W003031
PortaPak® Acetylene 80	Single-stage regulator suitable for light duty welding and cutting applications	Acetylene	0 - 80 kPa	1/4" LH	2 500 kPa	W003034

Series 6000 Single-Stage Single-Gauge Regulators

The Aprox Saffire® Series 6000 single-gauge LPG regulator is a compact, rugged regulator able to survive in tough working conditions whilst delivering efficient, dependable control of gas. The outlet pressure gauge allows for accurate setting of desired pressures. It incorporates a fully encapsulated Aprox valve for improved performance and precision-engineered components for greater safety.

Features

- Suitable for medium-to-heavy duty cutting and heating applications
- Flow rate is adequate for full range of LPG nozzles
- All regulators conform to the ISO 2503 standard and are quality tested at full service pressure for superior operator safety and control.



Afrox Saffire® Series 6000 Single-Stage Single-Gauge Regulators

Model	Description	Gas Type	Delivery Pressure	Inlet Connection	Outlet Connection	Max Inlet Pressure	Item Number
S6000 LGS 400	Single-stage 400 kPa Handigas (LPG) regulator suitable for the full range of Aprox LPG nozzles	Handigas (LPG)	0 - 400 kPa	5/8" LH	3/8" LH	2 500 kPa	W010611

Series 6000 Single-Stage Single-Gauge Regulators

The Afrox Saffire® Series 6000 single-gauge regulators are compact, rugged regulators able to survive in tough working conditions whilst delivering efficient, dependable control of gas. The outlet pressure gauge allows for accurate setting of desired pressures. It incorporates a fully encapsulated Afrox valve for improved performance and precision-engineered components for greater safety.

Features

- Suitable for medium duty welding and cutting applications
- Flow rate is adequate for full range of nozzles
- All regulators conform to the ISO 2503 standard and are quality tested at full service pressure for superior operator safety and control.



Afrox Saffire® Series 6000 Single-Stage Single-Gauge Regulators

Model	Description	Gas Type	Delivery Pressure	Inlet Connection	Outlet Connection	Max Inlet Pressure	Item Number
S6000 Oxygen	Single-stage 600 kPa Oxygen regulator suitable for the full range of Afrox nozzles	Oxygen	600 kPa	5/8" LH	3/8" LH	30 000 kPa	W003903
S6000 Acetylene	Single-stage 600 kPa Acetylene regulator suitable for the full range of Afrox nozzles	Acetylene	150 kPa	5/8" LH	3/8" LH	2 500 kPa	W003601

Flowmeters

Afrox Saffire® Series 6000 Flow-Gauge Regulator

The Aprox Saffire® Series 6000 Arc 40L is a two-gauge single-stage flow-gauge regulator measuring flow of up to 40 litres per minute. It incorporates a fully encapsulated Aprox valve for exceptionally consistent flow characteristics, longer life and improved performance, and precision-engineered components for greater safety.

The Arc 40L is a static flowmeter, where outlet flow is indicated on a suitably calibrated pressure gauge.

Features

- Suitable for general MIG and TIG welding applications where flow indication is not absolutely critical
- All regulators conform to the ISO 2503 standard and are quality tested at full service pressure for superior operator safety and control.



Afrox Saffire® Series 6000 Flow-Gauge Regulator

Model	Description	Gas Used	Max Gas Flow	Inlet Connection	Outlet Connection	Max Inlet Pressure	Item Number
S6000 Arc 40L	Combined single-stage regulator and flowmeter, with cylinder contents and flow gauges, for MIG/TIG welding using argon or carbon dioxide. Outlet gauge is calibrated in litres per minute	Argon, Carbon Dioxide	40 ℓ/min	5/8" RH	3/8" RH	30 000 kPa	W003610

Afrox Saffire® Integrated Regulator Flowmeter

This precision Aprox Saffire® Shieldmaster® pre-set regulator flowmeter is suitable for critical applications, such as shielding gas control for MIG and TIG welding, where an accurate gas flow needs to be set and maintained.

The integrated regulator flowmeter is a convenient regulator and dynamic flowmeter all in one. It is capable of delivering an adjustable flow from zero to 30 litres per minute.

Features

- MIG/TIG welding applications where an extremely accurate indication of flow is required
- Packaging/blanketing applications where an accurate low flow of gas is needed
- Process control in the technical, food and pharmaceutical industries.



Afrox Saffire® Integrated Regulator Flowmeter

Model	Description	Gas Used	Max Gas Flow	Inlet Connection	Outlet Connection	Max Inlet Pressure	Item Number
Shield-master®	Combined single-stage regulator and flowmeter, with cylinder contents and flow tube for MIG/TIG welding using argon or carbon dioxide. Outlet gauge is calibrated in litres per minute	Argon, Carbon Dioxide	0-30 ℓ/min	5/8" RH	3/8" RH	30 000 kPa	W003037

Saffire® 916 Multi-Stage Regulators

Features

- All Saffire® Legend 916 regulators certified to ISO 2503
- The Saffire® Legend 916 regulators are backed by a five-year warranty
- 100% tested at full service pressure for superior operator safety and control
- Unique Quadflo encapsulated valve technology
- 'Rain protect' bonnet protects the internal components from rain and moisture
- The Saffire® Legend 916 range offers multi-stage functionality, delivers constant pressure, even as the cylinder pressure reduces.



Afrox Saffire® Legend 916 Multi-Stage Heavy Duty Regulators

Model	Description	Gas Type	Delivery Pressure	Inlet Connection	Outlet Connection	Max Inlet Pressure	Item Number
Legend 916 OGM 1 000 kPa	Multi-stage, general purpose regulator with gauges	Oxygen	0 - 1 000 kPa	5/8" RH	9/16"	30 000 kPa	W232017
Legend 916 AGM 150 kPa	Multi-stage, general purpose regulator with gauges	Acetylene	0 - 150 kPa	5/8" LH	9/16"	2 500 kPa	W232018
Legend 916 OVM 1 000 kPa	Multi-stage, gaugeless visual indicator	Oxygen	0 - 1 000 kPa	5/8" RH	9/16"	30 000 kPa	W232013
Legend 916 AVM 150 kPa	Multi-stage, gaugeless visual indicator	Acetylene	0 - 150 kPa	5/8" LH	9/16"	2 500 kPa	W232015
Legend 916 OPM 350 kPa	Multi-stage preset gaugeless	Oxygen	350 kPa	5/8" RH	9/16"	30 000 kPa	W232303
Legend 916 APM 80 kPa	Multi-stage preset gaugeless	Acetylene	80 kPa	5/8" LH	9/16"	2 500 kPa	W232304

Regulator Spares, Fittings & Attachments

Afrox Saffire® Regulator Gauges

Acetylene Regulator Gauges

Description	Item Number
Contents Pressure 0 - 4 000 kPa	W003050
Outlet Pressure 0 - 220 kPa	W003054

- Suitable for S8500, S8000 & Legend 916 regulators
- Gauges conform to ISO 5171

PortaPak® Regulator Gauges

Description	Item Number
Pressure Gauges Kit (Contents & Outlet) Acetylene	W003048
Pressure Gauges Kit (Contents & Outlet) Oxygen	W003049

- Suitable for S5000 PortaPak® regulators
- Gauges conform to ISO 5171

Oxygen Gauges

Description	Item Number
Outlet Pressure 0 - 900 kPa	W003051
Contents Pressure 0 - 30 000 kPa	W003052
Outlet Pressure 0 - 1 600 kPa	W003053

- Suitable for S8500, S8000 & Legend 916 regulators
- Gauges conform to ISO 5171

Hydrogen Gauges

Description	Item Number
Contents Pressure 0 - 30 000 kPa	W003057
Outlet Pressure 0 - 1 600 kPa	W003058

- Suitable for S8500 hydrogen regulators
- Gauges conform to ISO 5171

Afrox Saffire® Regulator Fittings

Outlet Connections

Gas Type	Outlet Connection	Item Number
Acetylene	9/16" UNF LH	W003061
Oxygen	9/16" UNF RH	W003062



Inlet Stems & Nuts

Description	Item Number
Shieldmaster®	W003075
Oxygen/Argon	W003080
Acetylene/LPG/Hydrogen	W003081
Nitrogen	W003082
Nitrogen (Old Style)	W003083
Oxygen (Old Style)	W003084
Acetylene/Hydrogen (Old Style)	W003085



Inlet Stems & Nuts - PortaPak®

Description	Item Number
Kit - Acetylene and Oxygen	W003092



PortaPak® Inlet Stem Seals

Description	Item Number
Acetylene - Purple x one	W003077
Oxygen - Green x two	

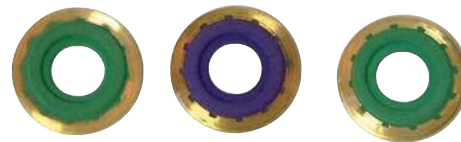

Afrox Regulator Attachments

Gauge Guard



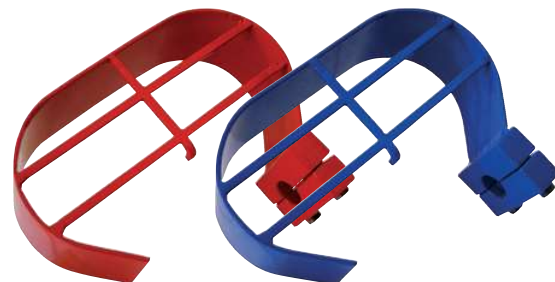

Description	Item Number
Red - Acetylene - Saffire®	W003201
Blue - Oxygen - Saffire®	W003202
Red - Acetylene - Legend	W003206
Blue - Oxygen - Legend	W003205



- W003201 and W003202 suitable for S8000 and S8500 regulators
- W003206 and W003205 suitable for Saffire® Legend 916 regulators
- Protects gauges from accidental damage

Torches & Attachments

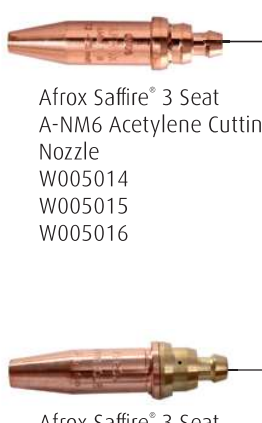
Cutting Assembly

<p>Cutting Nozzles</p>  <p>Afrox Saffire® 3 Seat Oxy-Acetylene A-NM6 Cutting Nozzle W005014 W005015 W005016 W005017 W005018 W005020</p> <p>Afrox Saffire® 3 Seat Oxy-LPG P-NM Cutting Nozzle W010236 W010237 W010238 W010239 W010240 W010242</p>	<p>Afrox Saffire® Torch</p>  <p>Afrox Saffire® Universal® Cutting Torch W005803</p>	<p>Cutting Nozzles</p>  <p>Afrox Saffire® 3 Seat A-NM6 Acetylene Cutting Nozzle W005014 W005015 W005016</p> <p>Afrox Saffire® 3 Seat LPG P-NM Cutting Nozzle W010236 W010237 W010238</p>	<p>Afrox Saffire® Torch</p>  <p>Afrox Saffire® Type 2 Cutting Attachment W005801</p> <p>Afrox Saffire® Type 2 Shank W005800</p>				
<p>Afrox Saffire® Flashback Arrestors</p> <table border="0"> <tr> <td>Afrox Saffire® Standard Flow Torch End Oxygen FBA W012031</td> <td>Afrox Saffire® Standard Flow Torch End Fuel FBA W012030</td> </tr> </table>		Afrox Saffire® Standard Flow Torch End Oxygen FBA W012031	Afrox Saffire® Standard Flow Torch End Fuel FBA W012030	<p>Afrox Saffire® Flashback Arrestors</p> <table border="0"> <tr> <td>Afrox Saffire® Standard Flow Torch End Fuel FBA W012030</td> <td>Afrox Saffire® Standard Flow Torch End Oxygen FBA W012031</td> </tr> </table>		Afrox Saffire® Standard Flow Torch End Fuel FBA W012030	Afrox Saffire® Standard Flow Torch End Oxygen FBA W012031
Afrox Saffire® Standard Flow Torch End Oxygen FBA W012031	Afrox Saffire® Standard Flow Torch End Fuel FBA W012030						
Afrox Saffire® Standard Flow Torch End Fuel FBA W012030	Afrox Saffire® Standard Flow Torch End Oxygen FBA W012031						

Please Note: For best results, always use genuine Afrox nozzles and Afrox parts.

Afrox Type 2 Welding Assembly

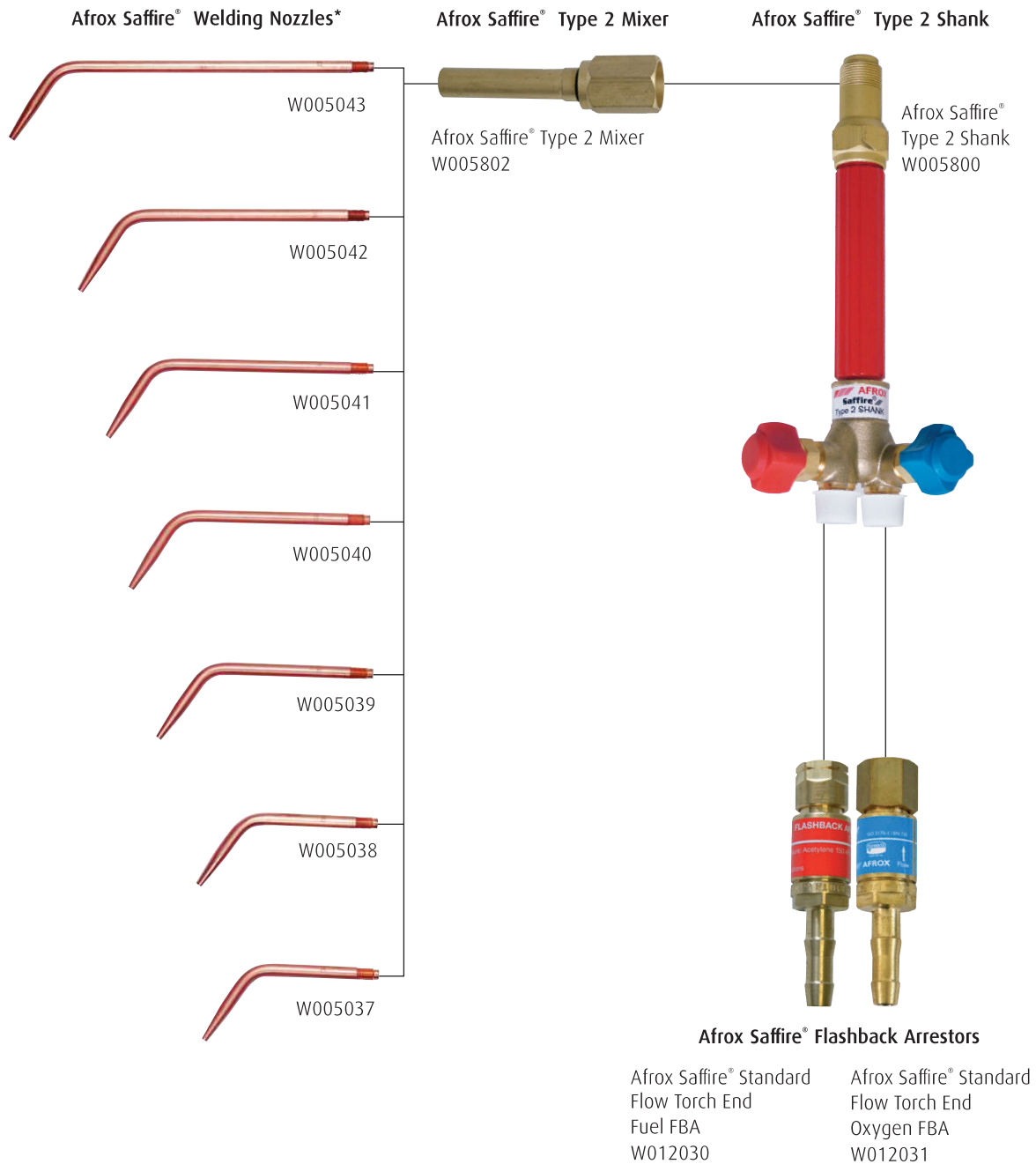

10

For Your Safety...

- Afrox recommends the use of flashback arrestors on both ends (regulator and torch).

Please Note: For best results, always use genuine Afrox nozzles and Afrox parts.

Type 2 Heating & Superheating Assembly

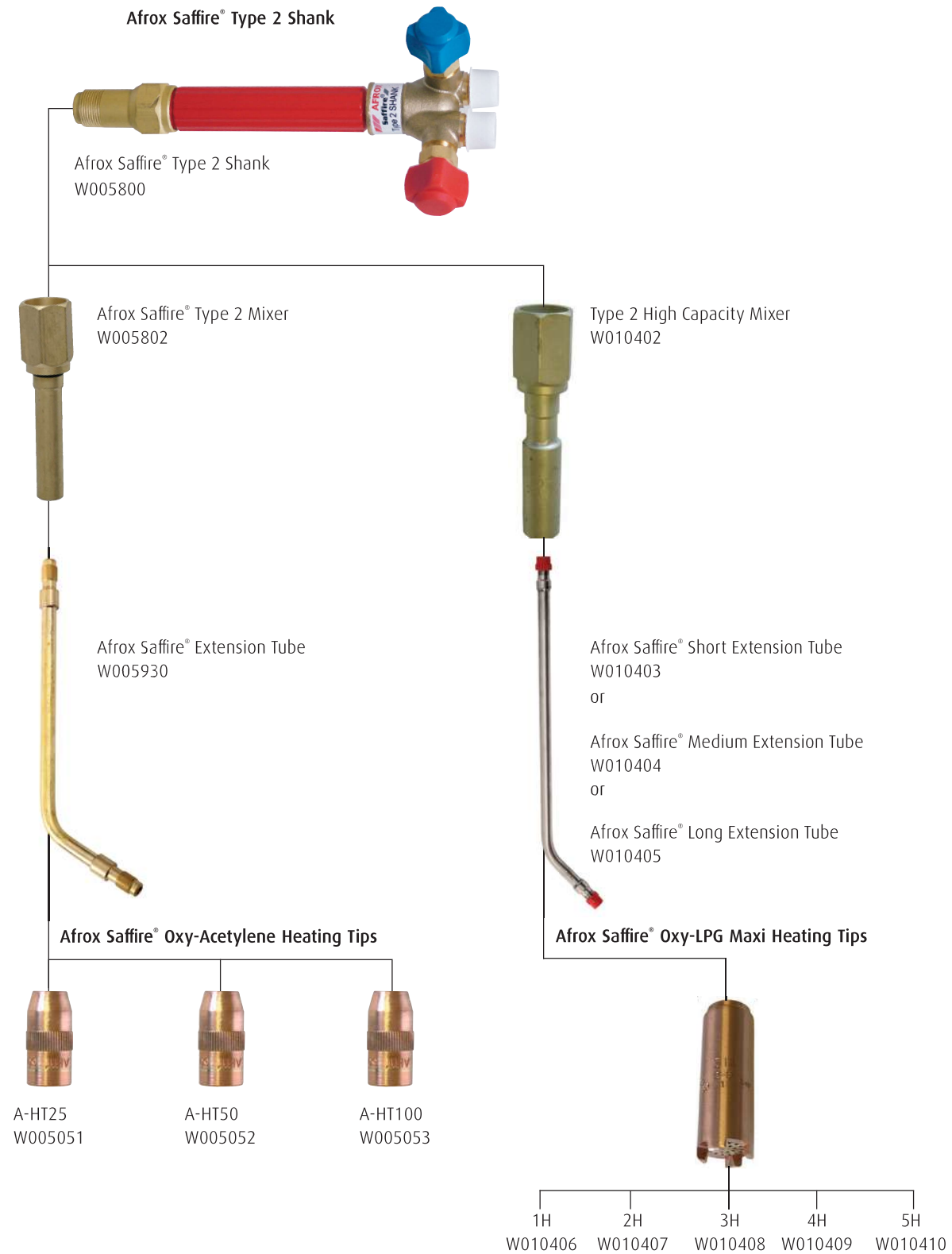

Please Note: For best results, always use genuine Afrox nozzles and Afrox parts.

Afrox Saffire® Universal® Cutting Torch



- A** Nozzle mixing helps contain backfires in the nozzle, protecting the torch from downtime and providing added operator safety
- B** Large forged head provides unmatched durability and reduces warping for extended service
- C** Three-tube construction keeps gases separate, allowing gas mixing only in the nozzle for added operator safety
- D** Solid lever for added durability
- E** Fully silver-brazed joints, thick-walled stainless steel tubes and solid brass forged head and tail result in robustness and lower maintenance costs
- F** Drag adjustment for setting desired valve resistance
- G** Easy-grip valves give you full control over your cutting flame
- H** Heavy duty handle for positive grip, comfort and control

Heavy Duty Gas Cutting



Universal® Cutting Torch

Features

- The Afrox Universal® is a versatile, robust and well-balanced torch capable of cutting steel up to 300 mm thick.
- It is compliant with ISO 5172 and comes with a one year warranty.
- Afrox Saffire® Universal® cutting torches feature nozzle mixing technology for added safety and for protecting the torch and operator from accidental backfires.
- Can be used with either acetylene or LPG depending on type of nozzle fitted
- Preheated oxygen and fuel gas are mixed in the nozzle for greater safety and resistance to backfire
- Special nozzles for gouging are also available.

Afrox Saffire® Universal® Cutting Torch

Gas Type	Torch Length	Head	Cutting Capacity (Steel)	Inlet Connection	Item Number
Acetylene or LPG	500 mm	90°	Up to 300 mm	3/8" BSP	W005803
Acetylene or LPG	1 000 mm	180°	Up to 300 mm	3/8" BSP	W005837
Acetylene or LPG	1 500 mm	180°	Up to 300 mm	3/8" BSP	W005838
Acetylene or LPG	2 000 mm	180°	Up to 300 mm	3/8" BSP	W005839
Acetylene or LPG	1 000 mm	90°	Up to 300 mm	3/8" BSP	W005840
Acetylene or LPG	1 500 mm	90°	Up to 300 mm	3/8" BSP	W005841
Acetylene or LPG	2 000 mm	90°	Up to 300 mm	3/8" BSP	W005842

Afrox Saffire® Legend 916 Heavy Duty Cutting Torch

Oxygen/Acetylene Cutting

The Saffire® Legend 916 is a heavy duty robust torch designed to perform in the harshest working conditions, but yet does so with the safety of the operator in mind. It is compliant with ISO 5172 and comes with a one year warranty.

The Saffire® Legend 916 has a brass underslung cutting oxygen lever for comfort, ease of operation and positive control, and is built for reliability and lasting control. This torch has a cutting capacity of up to 450 mm thick steel.



Features

- Tip mix principle - maximum operator safety
- Cutting capacity up to 450 mm thick steel
- Robust forged brass angle head for high strength, minimum distortion, positive tip seating and long service life
- Use with screw-in F tips
- Ease-on feature for cutting oxygen
- Needle torch control valves for fast, accurate flame adjustment
- Brass underslung cutting oxygen lever for comfort, ease of operation and positive control
- Stainless steel tubes for maximum strength and corrosion resistance
- All regulators conform to the ISO 2503 standard and are quality tested at full service pressure for superior operator safety and control.

Applications

- Cutting
- Ideally suited for mining, construction and quarry operations.

Important Note

For complete safe and economical operation of equipment, remember to always use correct pressures and fit flashback arrestors to both the torch and regulator.

The material thickness determines the correct tip size and this governs the correct pressure to be used.

Saffire® Legend 916 Heavy Duty Cutting Torch

Description	Gas	Head	Length (mm)	Inlet Connection	Item Number
Saffire® Legend 916	Acetylene	90°	510	9/16" UNF RH	W231001

Medium Duty Gas Cutting, Welding & Heating

Type 2 Cutting Attachment

Features

- Forged brass head and stainless steel tubes
- Cuts steel up to 75 mm with acetylene and with LPG
- Nozzle mixing of gases ensures greater safety
- Complete range of acetylene and LPG nozzles available
- It is compliant with ISO 5172 and comes with a one year warranty.

Combination Cutting Attachments & Shanks Afrox Saffire® Type 2 Cutting Attachment

Gas Type	Head	Cutting Capacity (Steel)	Inlet Connection	Item Number
Acetylene or LPG	90°	Up to 75 mm	3/8" BSP	W005801

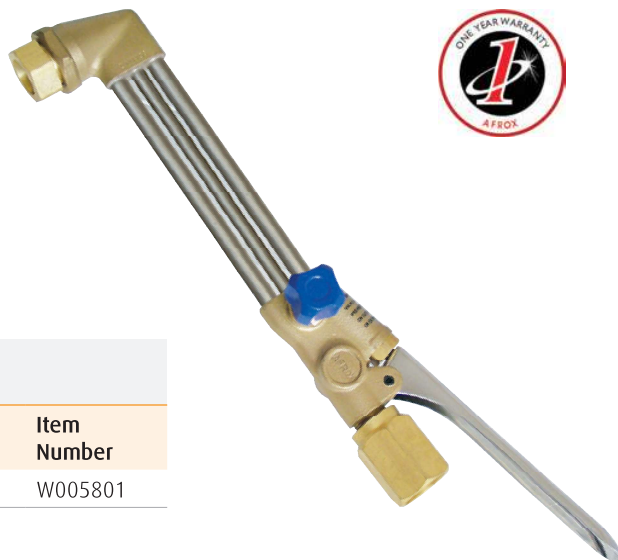

Afrox Saffire® Type 2 Shank

The Afrox Saffire® Type 2 is used in virtually every South African industry and has through the years been thoroughly tried and approved. The Afrox Saffire® Type 2 means real versatility in that its range of uses can be considerably extended by fitting various attachments for each process to the common shank.

Features

- Manufactured from extruded aluminium
- Hose connections 3/8" BSP
- It is compliant with ISO 5172 and comes with a one year warranty.

Afrox Saffire® Type 2 Shank

Gas Type	Weight	Cutting Capacity (Steel)	Inlet Connection	Item Number
Acetylene or LPG	530 g	Up to 35 mm	3/8" BSP	W005800



Light Duty Gas Cutting & Welding

PortaPak® Combi-Lite Shank

Features

- The new Combi-Lite Shank is to be used in conjunction with either the Combi-Lite Mixer or the Combi-Lite Cutting Attachment
- When used in conjunction with the Combi-Lite Mixer and the DH nozzles, the Combi-Lite turns into a welding and brazing torch
- Capable of welding and brazing materials up to 8 mm in thickness
- Ideally suited for use in workshops, garages, laboratories and production lines
- Its handy size and weight minimises operator fatigue over many hours of use
- It is compliant with ISO 5172 and comes with a one year warranty.

PortaPak® Combi-Lite Shank			
Gas Type	Cutting Capacity (Steel)	Inlet Connection	Item Number
Acetylene	Up to 35 mm	1/4"	W005716



PortaPak® Combi-Lite Cutting Attachment

Features

- The Combi-Lite Cutting Attachment is to be used in conjunction with the Combi-Lite Shank and can be used for cutting or welding by simply changing to the appropriate nozzle
- Use the LC nozzles for welding (capable of welding and brazing materials up to 4 mm)
- Use the AF-N nozzles for cutting (capable of cutting steel up to 35 mm)
- It is compliant with ISO 5172 and comes with a one year warranty.

PortaPak® Combi-Lite Cutting Attachment	
Gas Type	Item Number
Acetylene	W005719

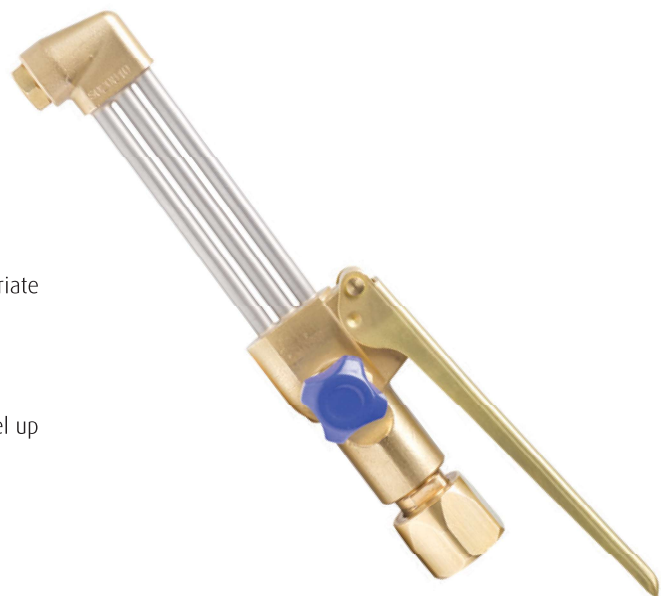



PortaPak® Combi-Lite Mixer

- To be used with the Combi-Lite Shank and DH nozzles

Item Number	W005718
-------------	---------

Mixers



Afrox Saffire® Type 2 Mixer

- Made of precision-machined brass and weighs only 150 g

Item Number	W005802
-------------	---------



Type 2 High Capacity Mixer

- Used for LPG heating and superheating applications

Item Number	W010402
-------------	---------

Extension Tubes



Afrox Saffire® Type 2 LPG Extension Tubes

Description	Item Number
LPG Short Extension Tube (300 mm)	W010403
LPG Medium Extension Tube (600 mm)	W010404
LPG Long Extension Tube (900 mm)	W010405



Afrox Saffire® Type 2 Acetylene Extension Tubes

Description	Item Number
Acetylene Extension Tube	W005930

Torch Spares & Accessories

10



Nozzle Nut - Combi-Lite Torch

Item Number	W005715
-------------	---------



Nozzle Nut - Type 2 and Universal® Cutting Torch

Item Number	W005850
-------------	---------



'O' Ring Kit - Type 2 Shank

Item Number W005820



Control Valve

- Oxygen - Type 2 cutting attachment

Item Number W012075

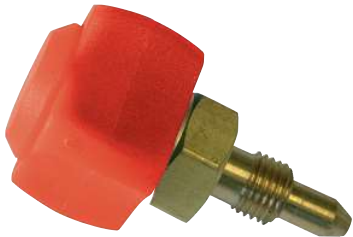

Control Valve

- Acetylene - Universal®/Type 2 shank

Item Number W012059

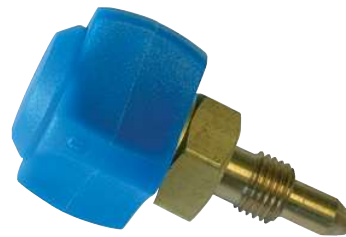

Control Valve

- Oxygen - Universal® / Type 2 shank

Item Number W012058



Double Roller Guide

- Fits Universal® and Type 2 torches

Item Number W005913



Circle Cutting Attachment

Item Number W005910

Nozzles

The Afrox range of nozzles utilises the nozzle-mix principle whereby the fuel gas and preheat oxygen are kept separate right up to the nozzle and are only mixed once inside the preheat orifices.

This system keeps the volume of mixed gas to an absolute minimum and therefore reduces the magnitude of a backfire. Injector-mix systems have far larger volumes of mixed gases in the torch and nozzle. Should a backfire occur, far more extensive damage to equipment, or operators, can result.

Nozzles are made of copper for good heat dissipation. Nozzle faces can be dressed back by using a fine file and orifices cleaned with appropriate cleaners. The flame shape and nozzle performance depend heavily on orifices having sharp, square edges – they should never be bell-mouthed by using pieces of wire to clean them out – use only approved nozzle cleaners.

Cutting Nozzles

Acetylene Hand Cutting – A-NM6

Nozzle Size	Material Thickness (mm)	Oxygen Pressure (kPa)	Acetylene Pressure (kPa)	Cutting Speed (mm/min)	Gas Consumptions			Item Number
					Oxygen Cutting (kg/h)	Oxygen Heating (kg/h)	Acetylene Heating (kg/h)	
0,8	3 - 6	150	15	500 - 850	1,13	0,41 0,69	0,31 0,52	W005014
1,2	6 - 12	200	15	440 - 700	2,45	0,49 0,82	0,37 0,62	W005015
1,6	12 - 25	250	15	300 - 610	5,37	0,56 1,06	0,44 0,76	W005016
1,6	25 - 50	300	20	230 - 400	6,23	0,60 1,06	0,49 0,76	W005016
1,6	50 - 75	350	30	180 - 300	7,03	0,76 1,06	0,49 0,76	W005016
2,0	75 - 100	300	30	180 - 250	9,55	0,76 1,17	0,56 0,87	W005017
2,4	100 - 150	300	30	150 - 180	13,92	1,17 1,62	0,87 1,20	W005018
3,2	150 - 250	450	35	100 - 125	29,84	1,65 2,06	1,23 1,54	W005020
3,2	250 - 300	550	35	90 - 125	34,48	1,88 2,42	1,39 2,00	W005020



Acetylene Machine Cutting – A-NME 6

Nozzle Size	Material Thickness (mm)	Cutting Speed (mm/min)	Cutting Oxygen Pressure (kPa)	Heating Oxygen Pressure (kPa)	Acetylene Pressure (kPa)	Oxygen Cutting (kg/h)	Gas Consumptions			Item Number
							Oxygen Heating (kg/h)	Acetylene Heating (kg/h)	Kerf Width (mm)	
0,8	3 - 6	620	150	30	15	1,13	0,69	0,52	2,0	W005021
1,2	6 - 12	530	200	35	15	2,62	0,87	0,67	2,0	W005022
1,6	12 - 25	425	300	35	15	5,3	0,96	0,71	2,8	W005023
1,6	25 - 50	270	300	35	20	5,3	1,2	0,91	2,8	W005023
1,6	50 - 75	170	350	40	30	6,1	1,2	0,91	4,0	W005023
2,0	75 - 100	155	350	40	30	10,4	1,5	1,1	4,0	W005024
2,4	100 - 150	140	400	50	30	16,4	1,7	1,3	5,5	W005025
3,2	150 - 250	100	560	60	35	35,6	2,4	1,7	6,5	W005026
3,2	250 - 300	90	560	60	35	35,6	2,4	1,7	6,5	W005026

Long pattern nozzles must always be used in cutting machines.



LPG Cutting – P-NM

Nozzle Size	Material Thickness (mm)	Cutting Speed (mm/min)	Cutting Oxygen Pressure (kPa)	Heating Oxygen Pressure (kPa)	LPG Pressure (kPa)	Gas Consumptions			Item Number
						Oxygen Cutting (kg/h)	Oxygen Heating (kg/h)	LPG Heating (kg/h)	
0,8	3 - 6	460	150	30	20	1,13	1,8	0,67	W010236
1,2	6 - 12	400	200	35	20	2,62	2,0	0,91	W010237
1,6	12 - 25	300	300	35	20	5,3	2,0	0,91	W010238
1,6	25 - 50	220	300	40	30	5,3	2,3	0,91	W010238
1,6	50 - 75	160	350	50	35	6,1	2,5	1,0	W010238
2,0	75 - 100	155	350	70	40	10,4	3,1	1,3	W010239
2,4	100 - 150	140	400	70	40	16,4	3,5	1,4	W010240
3,2	150 - 250	100	560	100	50	35,6	4,5	1,8	W010242
3,2	250 - 300	90	560	100	60	35,6	4,5	1,8	W010242

Type 2 torch, maximum cutting thickness is 75 mm.



Acetylene Sheetmetal Cutting – A-SNM

Material Thickness (mm)	Cutting Speed (mm/min)	Oxygen Pressure (kPa)	Acetylene Pressure (kPa)	Gas Consumptions			Item Number
				Oxygen Cutting (kg/h)	Oxygen Heating (kg/h)	Acetylene Heating (kg/h)	
Up to 3	460 - 560	150	15	1,12	0,11	0,09	W005057



Acetylene Cutting – A-FN (PortaPak®)

Nozzle Size	Material Thickness (mm)	Oxygen Pressure (kPa)	Acetylene Pressure (kPa)	Gas Consumptions			Item Number
				Oxygen Cutting (kg/h)	Oxygen Heating (kg/h)	Acetylene Heating (kg/h)	
0,8	3 - 6	200	15	0,94	0,34	0,25	W005708
1,2	20	200	15	1,84	0,34	0,25	W005709
1,6	25	200	15	4,49	0,34	0,25	W005710
1,6	35	200	20	4,78	0,34	0,30	W005710
1,6	50	500	20	5,98	0,41	0,31	W005710



Acetylene Gouging – A-GNM

Nozzle Size	Groove Width (mm)	Oxygen Pressure (kPa)	Acetylene Pressure (kPa)	Gas Consumptions			Item Number
				Oxygen Cutting (kg/h)	Oxygen Heating (kg/h)	Acetylene Heating (kg/h)	
13	8	400	50	4,9	1,3	0,9	W005061
19	11	500	50	12,4	2,4	1,8	W005062
25	13	550	55	21,6	3,0	2,2	W005063



Legend 916 2890-F Acetylene Cutting Tips

Description	Fits Torch	Plate Thickness (mm)	Oxygen Pressure (kPa)	Acetylene Pressure (kPa)	Item Number
0F	Legend 916	3 - 6	70	14	W231050
1F	Legend 916	6 - 19	70 - 170	14	W231051
2F	Legend 916	19 - 40	170 - 275	14	W231052
3F	Legend 916	40 - 100	345 - 450	28	W231053
4F	Legend 916	100 - 125	520 - 550	49	W231054
5F	Legend 916	125 - 150	585 - 620	70	W231055
6F	Legend 916	150 - 200	655 - 690	70	W231056
7F	Legend 916	200 - 300	760 - 895	70	W231057
8F	Legend 916	300 - 450	895 - 1 200	105	W231058



Welding Nozzles

It is important to select the correct size and type of nozzle to suit the nature of the job and the gas being used.

The use of a nozzle too large for the job may result in the welder turning down the flow of gases to try and set the small flame required. This creates a very unstable, soft flame which usually results in a backfire or flashback. Conversely, using a nozzle too small for the job results in turning up the gas flow and thus creating a very harsh flame. This is not dangerous but the flame tends to lift away from the tip of the nozzle and makes control of weld metal very difficult.

Afrox oxy-acetylene welding nozzles may also be used successfully with oxygen and Handigas for brazing and braze welding. It is usually necessary to use a larger nozzle than for oxy-acetylene due to the different ratio of oxygen to Handigas and the larger volumes involved.

Afrox oxy-acetylene welding nozzles may be used successfully with oxygen and hydrogen for special brazing and braze welding applications.

Afrox Saffire® Type 2 Welding Nozzles

Nozzle Size	Material Thickness (mm)	Nozzle Length (mm)	Oxygen Pressure (kPa)	Acetylene Pressure (kPa)	Gas Consumptions		Item Number
					Oxygen (kg/h)	Acetylene (kg/h)	
1	0,9	140	15	15	0,04 0,06	0,03 0,05	W005037
2	1,2	140	15	15	0,07 0,15	0,06 0,11	W005038
3	2,0	140	15	15	0,11 0,21	0,09 0,16	W005039
5	2,6	140	15	15	0,21 0,25	0,16 0,19	W005040
7	3,2	185	15	15	0,28 0,38	0,22 0,28	W005041
10	4,0	185	20	20	0,41 0,47	0,31 0,35	W005042
13	5,0	185	30	30	0,54 0,66	0,40 0,50	W005043
18	6,5	290	40	40	0,62 0,83	0,56 0,62	W005044
25	8,2	290	40	40	0,61 1,20	0,77 0,89	W005045
35	10	290	60	60	1,45 1,49	1,08 1,11	W005046
45	13	345	60	60	1,88 1,99	1,39 1,48	W005047
55	19	345	60	60	2,29 2,71	1,70 2,01	W005048
70	25	345	60	60	2,85 3,23	2,16 2,41	W005049
90	25+	345	60	60	3,72 4,20	2,78 3,15	W005050



Combi-Lite Welding Nozzles (PortaPak®)

Nozzle Size	Material Thickness (mm)	Nozzle Length (mm)	Oxygen Pressure (kPa)	Acetylene Pressure (kPa)	Gas Consumptions		Item Number
					Oxygen (kg/h)	Acetylene (kg/h)	
1	0,9	140	15	15	0,04 0,06	0,03 0,05	W005090
2	1,2	140	15	15	0,07 0,15	0,06 0,11	W005091
3	2,0	140	15	15	0,11 0,21	0,09 0,16	W005092
5	2,6	140	15	15	0,21 0,25	0,16 0,19	W005093
7	3,2	140	15	15	0,28 0,38	0,22 0,28	W005094
10	4,0	140	20	20	0,41 0,47	0,31 0,35	W005095
13	5,0	140	30	30	0,54 0,66	0,40 0,50	W005096
18	6,5	210	30	30	0,62 0,83	0,56 0,62	W005097
25	8,2	210	50	50	0,61 1,20	0,77 0,89	W005098



Combi-Lite Torch Welding Nozzles (PortaPak®)

Nozzle Size	Material Thickness (mm)	Nozzle Length (mm)	Oxygen Pressure (kPa)	Acetylene Pressure (kPa)	Gas Consumptions		Item Number
					Oxygen (kg/h)	Acetylene (kg/h)	
1	0,9	40	15	15	0,04 0,06	0,03 0,05	W005701
2	1,2	40	15	15	0,07 0,15	0,06 0,11	W005702
3	2,0	40	15	15	0,11 0,21	0,09 0,16	W005703
5	2,6	40	15	15	0,21 0,25	0,16 0,19	W005704
7	3,2	40	15	15	0,28 0,38	0,22 0,28	W005705
10	4,0	40	20	20	0,41 0,47	0,31 0,35	W005706



Heating Nozzles

Acetylene Spot Heating - A-HT

Nozzle Type	Oxygen Pressure (kPa)	Acetylene Pressure (kPa)	Gas Consumptions		Heat Output (kJ)	Use Mixer Item Number	Item Number
			Oxygen (kg/h)	Acetylene (kg/h)			
A-HT 25	30	30	1,46	1,20	55 000	W005802	W005051
A-HT 50	40	40	2,65	1,96	96 000	W005802	W005052
A-HT 100	70	50	3,98	3,27	146 000	W005802	W005053

Use with the Type 2 torch and bent neck tube 200 mm long (Item Number W005930).

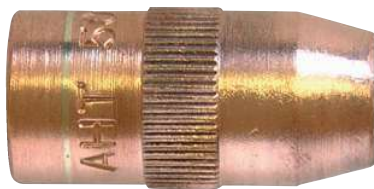

LPG Superheating

Nozzle Type	Oxygen Pressure Lo - Hi	LPG Pressure Lo - Hi	Gas Consumptions				Heat Output (kJ)	Use Mixer Item Number	Item Number
			Oxygen Lo (kg/h)	Oxygen Hi (kg/h)	LPG Lo (kg/h)	LPG Hi (kg/h)			
1H	70 - 200	15 - 50	4,64	9,68	1,64	3,74	76 000 172 000	W010402	W010406
2H	110 - 250	20 - 57	6,37	11,54	2,36	4,14	108 000 198 000	W010402	W010407
3H	180 - 500	30 - 110	11,01	21,88	4,14	8,08	193 000 380 000	W010402	W010408
4H	250 - 570	35 - 130	14,06	24,66	5,32	9,06	249 000 428 000	W010402	W010409
5H	350 - 870	85 - 200	16,84	37,13	6,31	13,79	265 000 652 000	W010402	W010410

Use with Type 2 torch, high capacity mixer and extension tube.



Please Note

10

- Heat output figures vary considerably with flame setting and regulator pressures
- Two typical readings are therefore given for each nozzle size at low and high pressures.

Flashback Arrestors & Quick Release Couplings

Flashback Arrestors

Core to the Afrox gas equipment safety offering is the Afrox flashback arrestor range. Afrox flashback arrestors are precision-manufactured, assembled and individually tested to the most stringent world-wide manufacturing standards. The superior quality of Afrox flashback arrestors makes them one of our most widely used products.

A flashback/detonation is a flame travelling at supersonic speed in the opposite direction to normal gas flow in oxy-fuel gas equipment. The backfeeding of gases that promotes flashbacks is generally caused by one of the following:

- Excessive pressure. If the flow rate exceeds the nozzle capacity, the gas at the higher pressure then flows into the lower-pressure gas line. This will occur if incorrect pressures are used or if nozzles, cutting attachments and welding torches are incompatible
- Lighting up incorrectly with both torch control valves open but one cylinder closed. In spite of better equipment, flashbacks remain a problem in oxy-fuel gas systems. There are many reasons for this, including the growing use of welding and cutting equipment by unskilled or semi-skilled persons who sometimes short-cut safety procedures in order to save time
- A drop in pressure of either gas due to leaks in the regulator, hose or connections. This could result in backfeeding into the low pressure line
- The reverse flow of gases during temporary storage or shutdown, incorrect closedown procedures or malfunctioning valves or regulators.

Features

- A** Inlet filter – a large stainless steel surface made from wire mesh to prevent foreign matter entering the unit
- B** Signal lever (resettable), drop-down shroud (premier)
- C** Non-return valve (NV) – a spring loaded valve preventing backfeed of gas upstream of the flashback arrestor
- D** Flame arrestor (FA) – a large sintered stainless steel element for repeatedly arresting flames
- E** Temperature-activated cut-off valve (TV), a valve that cuts off gas supply in the event of sustained, multiple flashbacks or a flame being held in the device. Once activated, this cannot be reset and the unit must be replaced (regulator mounted flashback arrestors only)

The Afrox resettable and premier flashback arrestors also feature

- F** A pressure-sensitive cut-off device (PV) – this valve isolates the gas supply if a backfeed of gas is detected. When this valve is activated, the signal lever B is raised or the shroud drops to alert the user to a potentially dangerous situation. Once the cause of the backfeed has been corrected, the flashback arrestor can be reset, and the user can continue in safety

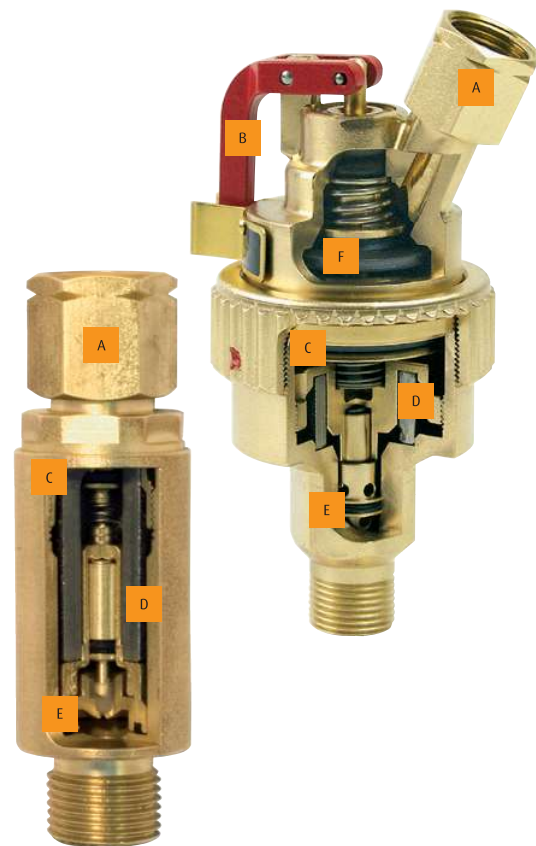

Maximum Working Pressures

Acetylene	150 kPa
LPG	500 kPa
Hydrogen	500 kPa
Air/Oxygen	2 000 kPa

How does a FBA work?

Normal flow conditions

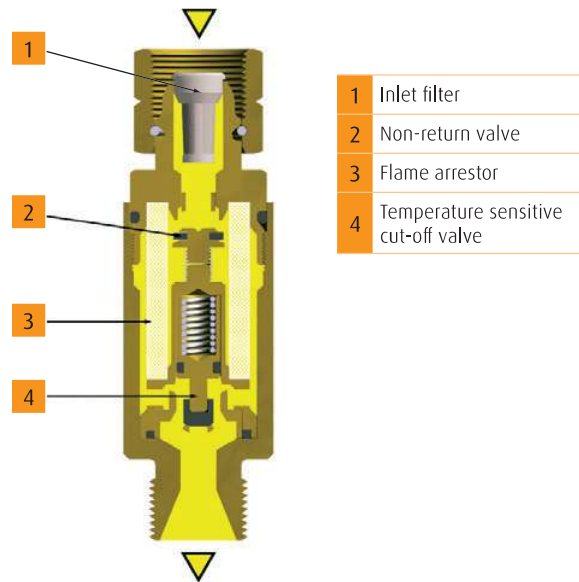

Reverse flow occurring

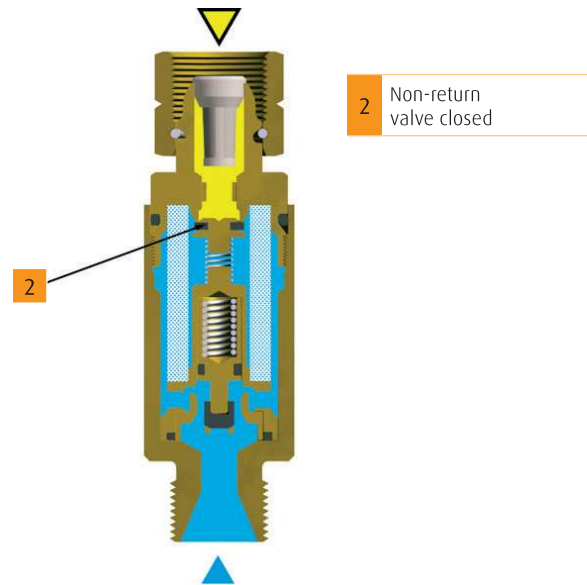

Non-return valve

Prevents the mixing of gases upstream of the FBA, thereby helping to prevent conditions conducive to a flashback occurring.

Flashback occurring

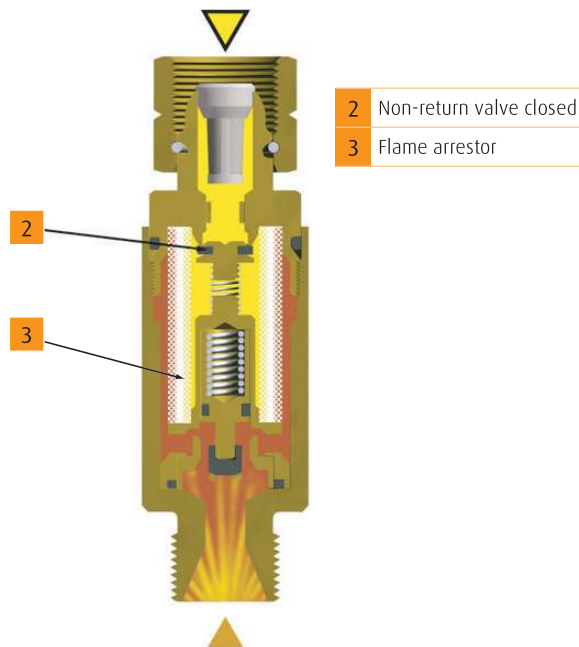

Flame arrestor

The flame arrestor (sintered element) is one of the key components of the FBA. It has very high thermal conductivity that quickly removes the heat from the flame – extinguishing it.

Sustained backfire occurring

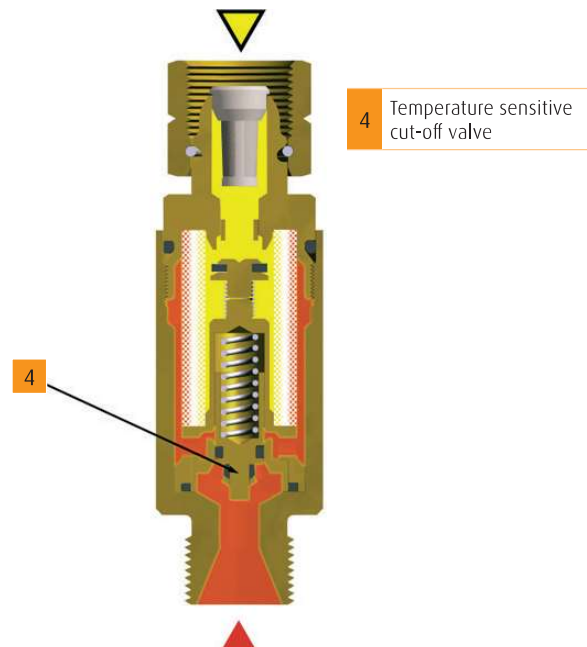

Thermal cut-off

As a final fail-safe in the event of repetitive flashbacks or sustained backfire, the thermal cut-off is activated and permanently cuts off the flow of gas.

Cartridge & Automatic Arrestors

Model	Gas	Inlet Connection	Outlet Connection	Description	Item Number
Afrox Super 90	Fuel Gas	3/8" BSP	3/8" BSP	Afrox Regulator Mount	W012020
Afrox Super 90	Oxygen	3/8" BSP	3/8" BSP	Afrox Regulator Mount	W012021



Model	Gas	Inlet Connection	Outlet Connection	Description	Item Number
Afrox F5	Fuel Gas	3/8" BSP	3/8" BSP	Afrox Regulator Mount	W012028
Afrox F5	Oxygen	3/8" BSP	3/8" BSP	Afrox Regulator Mount	W012029



Model	Gas	Inlet Connection	Outlet Connection	Description	Item Number
Afrox PortaPak®	Fuel Gas	1/4" BSP	1/4" BSP	PortaPak® Regulator Mount	W012017
Afrox PortaPak®	Oxygen	1/4" BSP	1/4" BSP	PortaPak® Regulator Mount	W012016



Model	Gas	Inlet Connection	Outlet Connection	Description	Item Number
Afrox 85-10	Fuel Gas	3/8" BSP	3/8" BSP	Afrox Regulator Mount	W012011
Afrox 85-10	Oxygen	3/8" BSP	3/8" BSP	Afrox Regulator Mount (Extra high flow)	W012012



Model	Gas	Inlet Connection	Outlet Connection	Description	Item Number
Afrox F7	Fuel Gas	8 mm Hose	3/8" BSP	Afrox Universal® and Type 2 Torch Mount	W012030
Afrox F7	Oxygen	8 mm Hose	3/8" BSP	Afrox Universal® and Type 2 Torch Mount	W012031



Model	Gas	Inlet Connection	Outlet Connection	Description	Item Number
Afrox F8	Fuel Gas	5 mm Hose	1/4" BSP	Afrox PortaPak®	W012032
Afrox F8	Oxygen	5 mm Hose	1/4" BSP	Torch Mount	W012033



Model	Gas	Inlet Connection	Outlet Connection	Description	Item Number
Afrox F9	Fuel Gas	3/8" BSP	3/8" BSP	Afrox Cutting	W012007
Afrox F9	Oxygen	3/8" BSP	3/8" BSP	Machine Torch Mount	W012008



Quick Release Couplings

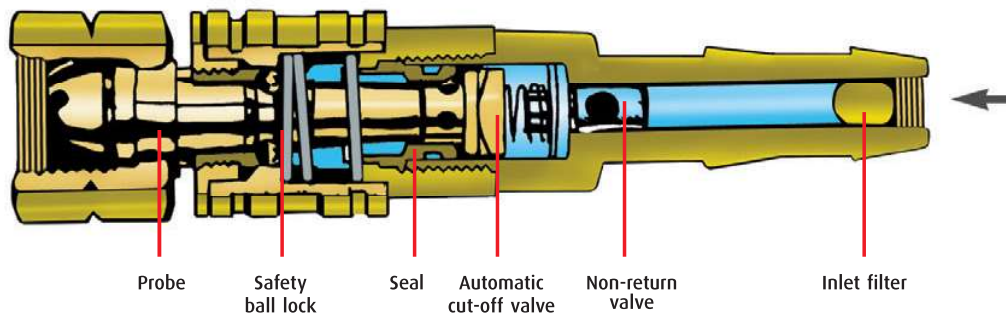

Quick release couplings make the connecting and disconnecting of hoses and regulators easy and quick. Safety is improved by incorporating non-return valves to prevent gases backfeeding and causing flashbacks.

Instant connection and disconnection of equipment provides added security and also saves time and money by avoiding lengthy changeover times.

Allows easy extension of hoses in a totally safe manner.

Non-interchangeable probes – absolutely impossible to mix hoses or gases.

Instant shut-off of gas when disconnected, even at maximum working pressures.

Non-return valves prevent any backfeeding of gases – providing greater safety.

Includes flashback arrestors for torch or regulator mount if required.

Conforms to DIN 8544 and ISO 7289 and carries approvals.

10

Maximum Working Pressures

Acetylene	150 kPa
LPG	500 kPa
Hydrogen	500 kPa
Air/Oxygen	2 000 kPa

Complete Kits for 8 mm Hose

Model	Description	Gas	Inlet Connection	Outlet Connection	Item Number
RF 53 NSK	From regulator to 8 mm hose with flashback arrestor. These probes are approved to the new ISO 7289 standard and are not interchangeable with current items	Oxygen	3/8" RH	8 mm Hose Nipple	W012120
		Acetylene/LPG	3/8" LH	8 mm Hose Nipple	W012121
CPN 460	8 mm hose to torch with 3/8" connections with flashback arrestor	Oxygen	3/8" RH	8 mm Hose Nipple	W012088
		Acetylene/LPG	3/8" LH	8 mm Hose Nipple	W012089



Test Equipment

WITT Test Panel

For bi-annual testing of flashback arrestors.

Item Number W012212

The following tests can be carried out:

1. Leak tightness to atmosphere.
2. Test of non-return valve against low and high back pressure.
3. Operating pressure of pressure-sensitive gas cut-off valve.
4. Leak tightness of pressure-sensitive gas cut-off valve.
5. Measurement of flow capacity.

Please Note: Not available for resale. Can only be purchased by end users who are required to undergo extensive training and assessment by qualified Aprox gas equipment specialists. Inexperienced operators, if untrained, are vulnerable to safety risks. Also available for Aprox Legend 916 compatible Flashback Arrestors.



Gas Hoses & Fittings

When did you last check your hose assembly?

Afrox Gas Hose Care and Maintenance

Hose has a limited life and the user must be alert to signs of impending failure, particularly when the conditions of service include high working pressures and/or the conveyance of hazardous materials.

Examples of dangerous and high risk hoses

Perished cover

The hose has perished due to prolonged exposure to UV, which accelerates the ageing process. This will result in the cover becoming brittle and cracking – therefore no longer protecting the reinforcement.

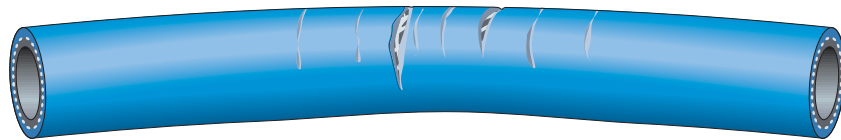

Perished cover

Cover wear

The cover is worn, exposing the reinforcement.

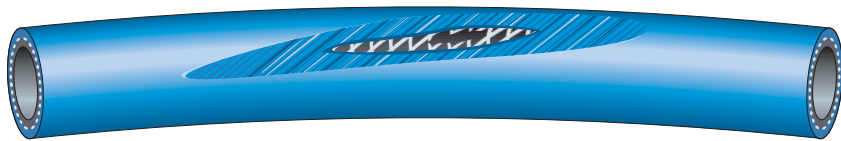

Cover wear

Scorched cover

Excessive heat will prematurely age the cover. This will result in the cover becoming brittle and cracking – therefore no longer protecting the reinforcement.

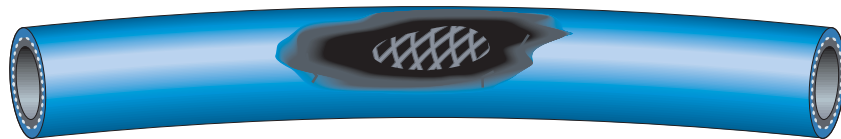

Scorched cover

Hoses & Fittings

The Afrox gas hose is high quality with a flame retardant outer and carries ISO approval for use with oxygen, acetylene and LPG.

The hose is colour-coded red for acetylene, blue for oxygen and orange for LPG.

Afrox LPG neoprene hose exceeds the requirements of SANS 1156-2 and carries ISO 3821 certification.

All Afrox gas hoses carry ISO 3821 certification.

Pre-Packed Hose (SANS Approved) - 5 mm

Description	Item Number
3 m Acetylene	W002600
3 m Oxygen	W002601
6 m Acetylene	W002602
6 m Oxygen	W002603
6 m Inert	W237100
100 m Inert	W237101

Pre-Packed Hose (SANS Approved) - 8 mm

Description	Item Number
6 m Acetylene	W002560
6 m Oxygen	W002561
12 m Acetylene	W002562
12 m Oxygen	W002563
18 m Acetylene	W002564
18 m Oxygen	W002565
30 m Acetylene	W002568
30 m Oxygen	W002569
50 m Acetylene	W002572
50 m Oxygen	W002573
100 m Acetylene	W002576
100 m Oxygen	W002577

Cut to Length Hose (SANS Approved)

Description	Item Number
5 mm Handigas (LPG Neoprene)	W002439
8 mm Handigas (LPG Neoprene)	W002440
Flexible Hose Outlet LH	W237158
Flexible Hose Outlet RH	W237159



Picture shown with optional hose connections



Hose Connection Kits

Description	Item Number
-------------	-------------

5 mm Hose Kit, 1/4" BSP R/H	W002270
-----------------------------	---------

5 mm Hose Kit, 1/4" BSP L/H	W002271
-----------------------------	---------

8 mm Hose Kit, 3/8" BSP R/H	W002274
-----------------------------	---------

8 mm Hose Kit, 3/8" BSP L/H	W002275
-----------------------------	---------

Comprise two nipples, two nuts and three 'O' clips

Parallel Hose Clips

Description	Item Number
-------------	-------------

5 mm Parallel Clip (Pack of 10)	W002530
---------------------------------	---------

8 mm Parallel Clip (Pack of 10)	W002531
---------------------------------	---------

'O' Clips

Description	Item Number
-------------	-------------

5 mm 'O' Clip (Pack of 10)	W002543
----------------------------	---------

8 mm 'O' Clip (Pack of 10)	W002544
----------------------------	---------

Hose Connection Nipples

Description	Item Number
-------------	-------------

5 mm Hose Nipple, Fits 1/4" Nut	W002518
---------------------------------	---------

5 mm Hose Nipple, Fits 3/8" Nut	W002175
---------------------------------	---------

8 mm Hose Nipple, Fits 3/8" Nut	W002170
---------------------------------	---------

Hose Connection Nuts

Description	Item Number
-------------	-------------

1/4" BSP Nut L/H	W002516
------------------	---------

1/4" BSP Nut R/H	W002517
------------------	---------

3/8" BSP Nut L/H	W002166
------------------	---------

3/8" BSP Nut R/H	W002167
------------------	---------

Fittings for Hose Joining

Description	Item Number
-------------	-------------

5 mm Equal Hose Joiner (2 of incl. 4 'O' clips)	W002171
----------------------------------------------------	---------

8 mm Equal Hose Joiner (2 of incl. 4 'O' clips)	W002172
----------------------------------------------------	---------

Equal Hose Coupler

Description	Item Number
-------------	-------------

3/8" BSP Equal Hose Coupler L/H (2 of)	W002176
-------------------------------------------	---------

3/8" BSP Equal Hose Coupler R/H (2 of)	W002177
-------------------------------------------	---------

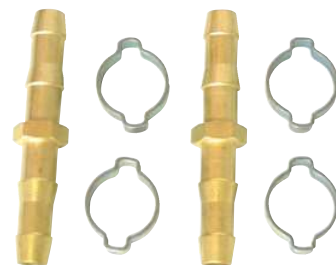

Gas Equipment Accessories

Afrox Saffire® Safetest Leak Detection Solution

Description	Item Number
-------------	-------------

For Leak Testing of Gas Equipment & Gas Pipelines	W012045
---------------------------------------------------	---------



Afrox Saffire® Standard Nozzle Cleaners

Description	Item Number
-------------	-------------

For One Piece Nozzles	W012172
-----------------------	---------





Industrial Cylinder Trolley

Item Number

W012035



'O' Clip Crimping Tool

Item Number

W012580



Aprox Saffire® Boilermaker's Chalk

Item Number

W012176



Multi-Purpose Spanner

Multi-Purpose Spanner

Description	Item Number
Saffire® range	W012590
Legend range	W237304



Triple Flint Spark Lighter

• Includes spare replacement flint

Item Number

W012621



Regulator Spanner - 27 mm

Item Number

W012585



Triple Flint Replacement Flint - 3 Sets

Item Number

W012622

PortaPak[®]

The Afrox PortaPak[®] is the ideal welding and cutting set for those difficult-to-get-to jobs. Light and robust, with man-sized capabilities, it is easily moved by one person, and can be lifted through hatches or into service vehicles. Because of its small size and portability, the set is ideal for emergency vehicles or on maintenance duty in industry where portability is a must.

Welding and Cutting Capabilities

The PortaPak[®] can be used for fusion weld, braze weld, silver solder, heating and cutting. Nozzles provided will fusion weld steel up to 4 mm and cut steel up to 50 mm thick. The cutting capability can be extended to 20 mm by using the AFN 1,2 mm or to ± 35 mm using the AFN 1,6 mm nozzle available as an optional extra.

Continuous Operating Times

Brazing and welding with No. 5 nozzle – six hours. Cutting with 0,8 mm nozzle – 45 minutes. These times are for non-stop operation. The average job requires a fair amount of preparation and welding and cutting is normally intermittent, which in practice extends these times considerably.

Features

Regulators

Single-stage regulators that give exceptional performance and reliability. Both are equipped with gauges indicating cylinder and outlet pressures. Gauges are colour-coded for easy and safe setting of welding and cutting pressures. When replacing regulator stem sealing washers, use only the correct Afrox replacement parts (see ordering information).

Accessory Box

Convenient robust metal box with provision to hold the full range of nozzles, flint lighter, goggles, and spanner.

Cylinders

Capacities: oxygen 1,43 kg, acetylene 0,9 kg.

There are no rentals or deposits on the cylinders but a charge will be made for subsequent refills.

Cylinders may only be filled by Afrox.

Filler Rod Holder

Easily removable holder allows access to short lengths of filler rods.

Trolley

Designed as a robust lightweight unit, it gives maximum mobility and incorporates a positive cylinder-securing device ensuring safe handling of the set. A lifting eye is provided at the centre of gravity to enable safe hoisting of the unit.

Torch

The Afrox Combi-Lite Torch converts from welding to cutting by simply changing the nozzle.

Flashback Arrestors

For ultimate safety, regulator and torch mounted flashback arrestors are incorporated as standard equipment, thereby eliminating any possibility of ignition of mixed gases in the hoses.

Hose

Completely assembled industrial grade 5 mm SANS approved hoses, supplied in 3 m lengths and fitted with safety flashback arrestors that protect against mishaps. The hose is flame retardant, durable and resistant to abrasion.



Ordering Information

The Outfit Comprises

Description	Item Number
Oxygen Cylinder	W005740
Acetylene Cylinder	W005782
Complete Accessory Kit	W005772

The Accessory Kit Comprises

Description	Item Number
Oxygen Regulator	W003031
Acetylene Regulator	W003034
PortaPak® Combi-Lite Shank	W005716
PortaPak® Combi-Lite Cutting Attachment	W005719
3 m Lengths of Fitted Hose Acetylene (DA) *	W002600
3 m Lengths of Fitted Hose Oxygen (O ₂) *	W002601
Parallel Hose Clips	W002530
Goggles	W012257
Multi-purpose Spanner	W012590
Triple Flint Lighter	W012621
Data Card	N/R
Replacement Inlet Stem Seals (Two x O ₂ , one x DA)	W003077
Nozzle Cleaners	W012172
Reg. Mount Flashback Arrestor Acetylene	W012017
Reg. Mount Flashback Arrestor Oxygen	W012016
Torch Mount Flashback Arrestor Acetylene	W012032
Torch Mount Flashback Arrestor Oxygen	W012033
No. 1 LC Nozzle	W005701
No. 3 LC Nozzle	W005703
No. 7 LC Nozzle	W005705
AFN 1,2 Cutting Nozzle	W005709
AFN 1,6 Cutting Nozzle	W005710
No. 3 Welding Nozzle	W005092
No. 5 Welding Nozzle	W005093
No. 7 Welding Nozzle	W005094

* Fittings sold separately

Gas Welding & Cutting Outfits

Afrox Saffire® Type 2 Economy Outfit

The Aprox Saffire® Type 2 Economy Outfit is designed to get you started on general oxy-acetylene welding and cutting, with the flexibility to add accessories specific to your personal and job requirements – creating your own specially customised kit. The economy outfit is presented in a useful toolbox.

The Series 6000 regulators in the outfit feature unique Aprox encapsulated valves, which provide extremely stable control of gases. The versatile and robust Aprox Saffire® Type 2 shank and cutting attachment are constructed from solid brass forgings and have silver-brazed joints for extra strength.

Description	Item Number
A flexible outfit that is ideal for oxy-acetylene welding and cutting, but can be customised to suit your needs	W005860



- | | |
|----------------------------------------------------|----------------------------------|
| A Toolbox | I Type 2 shank |
| B Medium-duty welding nozzle - No. 7 | J Multi-purpose spanner |
| C Cutting nozzle ANM - 0,8 mm | K Nozzle cleaners |
| D Acetylene regulator Series 6000 - 150 kPa | L Triple flint lighter |
| E Oxygen regulator Series 6000 - 400 kPa | M Type 2 mixer |
| F F5 regulator mounted flashback arrestors | N Fitted hose (oxygen) |
| G F7 torch mounted flashback arrestors | O Fitted hose (acetylene) |
| H Type 2 cutting attachment | P Goggles |

Also included but not shown:

- Operation and instruction manual

Please Note: For ultimate safety, always use genuine Aprox Saffire® flashback arrestors and parts. Replacement parts are available for all outfits.

Afrox Saffire® Type 2 Professional Outfit

The Aprox Saffire® Type 2 Professional Outfit is a top-of-the-range premium outfit – the supreme kit for professionals and all welding, brazing, heating and cutting operations, presented in a reusable toolbox. The outfit is capable of cutting up to 75 mm and welds up to 5 mm.

The Series 8500 regulators in the outfit feature unique Aprox encapsulated valves, which provide extremely stable control of gases. The versatile and robust Aprox Saffire® Type 2 shank and cutting attachment are constructed from solid brass forgings and have silver-brazed joints for extra strength.

Description	Item Number
A premium outfit for welding, brazing, heating and cutting application	W005861



- | | |
|-----------------------------------------------------------|----------------------------------|
| A Toolbox | K Type 2 shank |
| B Heating neck tube | L Multi-purpose spanner |
| C Acetylene heating nozzle | M Nozzle cleaners |
| D Medium-duty welding nozzles - No. 2, 3, 5, 7, 13 | N Triple flint lighter |
| E Cutting nozzles ANM - 0,8, 1,2, 1,6 | O Type 2 mixer |
| F S8500 AGM 150 kPa multi-stage regulator | P Fitted hose (oxygen) |
| G S8500 OGM 400 kPa multi-stage regulator | Q Fitted hose (acetylene) |
| H F5 regulator mounted flashback arrestors | R Goggles |
| I F7 torch mounted flashback arrestors | S Circle cutting guide |
| J Type 2 cutting attachment | |

Also included but not shown:

- Operation and instruction manual

Please Note: For ultimate safety, always use genuine Aprox Saffire® flashback arrestors and parts. Replacement parts are available for all outfits.

Sievert® Equipment

Established in 1882, Sievert® AB is a Swedish world-leading manufacturer of LPG and electric-powered heating tools for professionals.

Product development takes place in close collaboration with customers and cooperative partners. Sievert® heating tools and equipment are used by professionals in mining, construction, oil and gas, automotive, plumbing, energy and telecom industries.

Whether you should preheat large structural steel parts, apply heat shrinking sleeves on telecom connections, heat up mechanical rusted parts to unlock them, or braze HVAC copper pipes, Sievert® offers a complete range of heating tools for maintenance and repairing operations.



Sievert® Promatic range

Promatic is the most advanced and safest system in the Sievert® range. The patented piezoelectric ignition, universal handle, advanced design and ergonomic appearance make Promatic a superior system for all possible heating tasks where efficiency and professional workmanship are the most important requirements.

Promatic operates with propane and butane gases.

Promatic Handle

- Plastic composite handle reinforced with 30% glass fibres for maximum durability
- Double moulded soft grip for highest comfort and usability
- Piezo igniton with instant trigger on/off function
- Bayonet fitting for burners: no gas emission until burner is fitted for maximum safety
- Swivelling hose connection to avoid hose drag
- Combined suspension hook and footstand
- Valve for precise flame setting.



Sievert® Model No.	Working Pressure	Length	Height	Weight	Item Number
336611	1,5-4 bar	180 mm	80 mm	290 g	W010020

Hose connections BSP 3/8" LH



Promatic Soft Flame Burner

Ideal for cable work and other heat shrinking applications.

Sievert® Model No.	Burner Diameter	Gas Consumption	Heat Effect	Item Number
334191	38 mm	900 g/h at 2 bar	11,5 kw	W010028

For thick walled sleeves max, 150 mm. Also for thin walled sleeves.



Promatic Cyclone Burner

Ideal for brazing and soft soldering thanks to the rotating flame that provide an all-around heat transfer to the pipe.

Sievert® Model No.	Burner Diameter	Gas Consumption	Soft Soldering	Heat Effect	Item Number
333501	19 mm	250 g/h at 2 bar	± 400°C	3,2 kw	W010022

Soft soldering about 400°C max. pipe diameter – 32 mm.
Brazing up to 720°C max. pipe diameter – 18 mm.

Sievert® PRO 86-88 Range

Sievert® PRO range is based on two universal handles that can be equipped with different necktubes and burners all compatible, to create the perfect torch system according to specific customer needs.

Sievert® Pro 86 Handle

- Single-valved handle mainly for smaller burners
- The spindle and valve are designed to give a very exact and quick flame setting
- The spring loaded metal knob gives a precise and stable setting for the finest of flames
- All metal parts made of high quality brass
- Ergonomically designed plastic composite handle
- Double moulded soft grip for highest comfort and usability.



Sievert® Model No.	Working Pressure	Length	Height	Weight	Item Number
348641	1,5-8 bar	180 mm	70 mm	245 g	W010108

Sievert® Pro 88 Handle

- Double-valved handle mainly for larger burners
- Incorporates one main valve and one economiser valve enabling a gas saving pilot flame
- Trigger for instant shifting between pilot and main flame and for pulsing the main flame
- All metal parts made of high quality brass
- Ergonomically designed plastic composite handle
- Double-moulded soft grip for highest comfort and usability.



Sievert® Model No.	Working Pressure	Length	Height	Weight	Item Number
348841	1,5-8 bar	205 mm	90 mm	385 g	W010109

Sievert® PRO Neck Tubes

Shorter neck tubes are recommended for smaller heating applications like gold and silver forging. Longer neck tubes are recommended for larger jobs like metal preheating, roofing and road work. Titanium neck tube weighs up to 60% less than brass and provides a better heat transfer, ideal for preheating applications.



Sievert® Model No.	Length	Material	Item Number
350902	180 mm (with hook)	Brass	W010105
351001	350 mm	Brass	NEW (Available on Request)
350701	500 mm	Brass	NEW (Available on Request)
350601	750 mm	Brass	W010106
355601	750 mm	Titanium	NEW (Available on Request)

Sievert® PRO Burners

Sievert® burners are designed for high-pressure operation (200 kPa) and all of them can be connected to the universal handles by means of the neck tubes. The special design ensures that cool primary air forms a cooling air gap between flame and burner tube, thus ensuring a very long burner lifetime. Each burner is individually flame-tested before delivery.

Sievert® PRO Pin-point Burners

Finest flame for precision works such as gold and silver forging. Working pressure 2 bar.

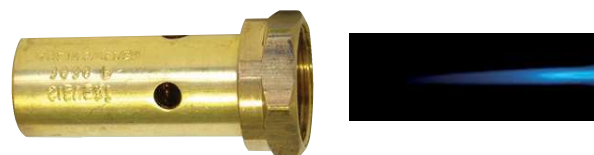

Sievert® Model No.	Burner Diameter	Material	Gas Consumption at 2 Bar	Heat Effect	Max Pipe Diameter Soft Soldering	Item Number
393802	17 mm	Brass	20 g/h	0,25 kw	10 mm	W010146

Sievert® PRO Standard Burners

Brush-type flame for all kinds of soft soldering – small heating applications. Working pressure 2 bar.



Sievert® Model No.	Burner Diameter	Material	Gas Consumption at 2 Bar	Heat Effect	Max Pipe Diameter Soft Soldering	Item Number
394002	17 mm	Brass	90 g/h	1,2 kw	12 mm	W010119



Sievert® Model No.	Burner Diameter	Material	Gas Consumption at 2 Bar	Heat Effect	Max Pipe Diameter Soft Soldering	Item Number
294102	28 mm	Brass	600 g/h	7,7 kw	60 mm	W010120

Sievert® PRO Power Burners

Heavy duty power burners with extremely strong and wind-proof flame. Ideal for preheating before welding, bitumen laying, drying, field torching and other heat demanding applications. Working pressure 4 bar. Titanium burner weighs up to 60% less than brass and provides a better heat transfer, ideal for preheating applications.



Sievert® Model No.	Burner Diameter	Material	Gas Consumption at 4 Bar	Heat Effect	Item Number
294302	35 mm	Brass	3,350 g/h	43,5 kw	W010122



Sievert® Model No.	Burner Diameter	Material	Gas Consumption at 4 Bar	Heat Effect	Item Number
294402	50 mm	Brass	6,700 g/h	86,0 kw	W010123



Sievert® Model No.	Burner Diameter	Material	Gas Consumption at 4 Bar	Heat Effect	Item Number
295401	70 mm	Titanium	12,500 g/h	155,0 kw	NEW (Available on Request)

Hose and Hose Nipples

Use only Type B nitrile compound hose on LPG. The normal rubber lined acetylene hoses are not suitable as LPG perishes the lining, causing it to break up. Small particles will then block the extremely small holes in the burner jets.

Description	Item Number
Hose - 5 mm	W002439
Hose - 8 mm	W002440

Suitable for 5 and 8 mm Type B nitrile compound hose. The design is such that, whilst providing a gas tight joint, the hose nipple is free to rotate, thereby avoiding hose kinks as the operator moves about the job.

Description	Item Number
Rotating Nipple & Nut	W010174



Always use Sievert® equipment with Afrox Saffire® S6000 LPG 400 Regulator (Item Number W010611).



Gas Cutting Machines

Portable Automatic Gas Cutting Machine

The IK-12MAX3 is a high quality motor driven portable flame cutting machine designed to cut straight lines, circles and bevels with clean, sharp, smooth edges.

- All functions controlled by forward/off/reverse switch, clutch lever and speed adjustment knob
- Versatility and convertibility inherent in the design ensure all types of straight line, circle and bevel cutting are simply performed
- Use of Afrox A-NME oxy-fuel cutting nozzles in conjunction with the uniquely accurate guidance driving system provides unequalled performance in the cutting of clean, sharp and smooth edges
- Plate track for straight line cutting is available in interlocking sections of 1 800 mm each which may be extended indefinitely

- An adjustable radius bar for circle cutting and a circle cutting track are optionally available
- High speed mode in the range of 240 - 2 400 mm/min at 50 cycle and 300 - 3 000 mm/min at 60 cycle is available
- The exclusive Double Cone Reduction Gear system provides very smooth travelling and therefore set speed is kept in any of long time operation.



Description	Item Number
1K-12MAX3 Portable	W014112

Specifications	IK-12MAX3
Cutting Speed (Standard type)	80 - 800 mm/min
Travelling Speed (High speed type)	240 - 2 400 mm/min
Speed Control	Double cone stepless speed control system
Speed Meter	Dial induction (w/conversion scale)
Power	42/110/220 V AC
Machine Dimensions	Length 430 mm Width 170 mm Height 215 mm
Max. Loading Weight	50 kg
Weight	10 kg

Optional Extras / Spares	Afrox Item Number
IK-12MAX3 Track 1,8 m	W014111
IK-12MAX3 Heatshield	W014113
Torch Block Model SP400	W014131

Afrox BlueBox Heavy Duty Oxy-Acetylene Kit

Description	Item Number
Afrox BlueBox Heavy Duty Oxy-Acetylene Kit	W230614

Ideal for rugged working environments, such as mines, construction sites, shipyards, quarries, scrap cutting yards and heavy fabrication sites.

The Aprox BlueBox offer is not just a product, it is a unique service offer as well. This service offer entails the following:

- Serialised numbering of boxes and equipment for tracing and accountability
- Servicing of the equipment by specialist Aprox personnel on a pre-determined schedule as agreed with the customer
- Better cost control
- Improved safety and risk control
- Longer lasting products
- Only ISO/SANS approved equipment is used.

Features

- Saffire® Legend 916 acetylene cutting torch capable of cutting up to 450 mm plate
- Leak/pressure tested at Aprox Gas Equipment Factory
- Tip mix minimising risk of flashbacks
- Regulator to tip pre-assembled
- 9/16" connectors and fittings
- Cutting of up to 450 mm thick steel with the right sized cutting tip.

Applications

- Steel cutting up to 450 mm with an 8F cutting tip.

Kit Consists of

- | | |
|-----------------------------------------------------------------------------|---------------------------------------------------|
| A Saffire® Legend 916 cutting torch | H Multi-purpose spanner |
| B Saffire® Legend 916-1F tip | I Tip cleaner |
| C Saffire® Legend 916-105K acetylene multi-stage gaugeless regulator | J Triple flint lighter and one spare flint |
| D Saffire® Legend 916 oxygen multi-stage gaugeless regulator | K Safetest leak detection solution |
| E DGN regulator mounted flashback arrestors | L Blue and yellow welding gauntlet |
| F GT torch mounted flashback arrestors | M Gas welding goggles |
| G 18 m oxygen and acetylene flexible gas hoses (SANS approved) | N Plastic blue box |

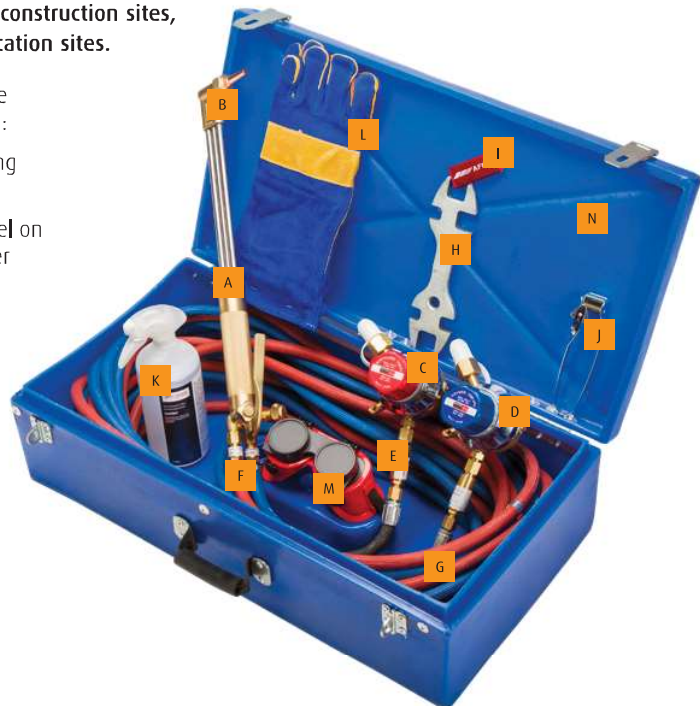

Afrox RedBox Heavy Duty Oxy-Acetylene Kit

Description	Item Number
Afrox RedBox Heavy Duty Oxy-Acetylene Kit	W230600

Ideal for rugged working environments, such as mines, construction sites, shipyards, quarries, scrap cutting yards and heavy fabrication sites.

The Aprox RedBox offer is not just a product, it is a unique service offer as well. This service offer entails the following:

- Serialised numbering of boxes and equipment for tracing and accountability
- Servicing of the equipment by specialist Aprox personnel on a pre-determined schedule as agreed with the customer
- Better cost control
- Improved safety and risk control
- Longer lasting products
- Only ISO/SANS approved equipment is used.

Features

- The Saffire® Universal® torch can cut up to 300 mm thick steel with the correct size ANM6 cutting nozzle
- Aprox Saffire® multi-stage regulators are ISO 2503 approved
- 'Set and forget' technology – constant pressure delivery
- Flashback arrestors are SANS 50730-1 approved
- Gas hoses are SANS 3821 approved
- 3/8" outlet connectors and fittings.

Applications

- Steel cutting of up to 300 mm with a 3,2 ANM6 nozzle.

Kit Consists of

- | | |
|--------------------------------------------------------------|-----------------------------------------------------------|
| A Saffire® cutting torch | I Nozzle cleaner |
| B Saffire® S8500 acetylene multi-stage regulator | J Triple flint lighter |
| C Saffire® S8500 oxygen multi-stage regulator | K Safetest leak detection solution |
| D Saffire® ANM6 1,6 cutting tip | L Gas welding goggles |
| E Saffire® F5 regulator-mounted flashback arrestors | M Aprox red chrome leather gauntlet gloves – 20 cm |
| F Saffire® F7 torch-mounted flashback arrestors | N Plastic red box |
| G 18 m oxygen and acetylene gas hoses (SANS approved) | O Boiler Makers Chalk |
| H Multi-purpose spanner | |



IBEDA

Flashback Arrestors & Quick Release Couplings

Regulator Mounted Flashback Arrestors

IBEDA Standard Flashback Arrestor with Thermal Cut-Off Valve

This safety device can be used for

- Welding up to 30 mm
- Flame cutting up to 60 mm
- Heating up to 50 mm.

Safety Features

- Dust inlet filter promoting longer life
- Non-return valve preventing dangerous gas mixtures
- Flame arrestor preventing flashbacks
- Thermal cut-off valve prevents excessive temperatures.



IBEDA Standard Flashback Arrestor with Thermal Cut-Off Valve

Description	Gas	Maximum Air Flow (L/H)	Maximum Pressure (kPa)				Inlet Thread	Outlet Thread	Item Number
			O ₂	Da	LPG	H ₂			
DGN	Fuel	32 600	-	150	500	350	9/16" UNF LH	9/16" UNF LH	W236001
DGN	O ₂	32 600	2 000	-	-	-	9/16" UNF RH	9/16" UNF RH	W236002

IBEDA High Flow Flashback Arrestor with Thermal Cut-Off Valve

This safety device can be used for

- Welding up to 30 mm
- Flame cutting up to 500 mm
- Heating >100 mm.

Safety Features

- Dust inlet filter promoting longer life
- Non-return valve preventing dangerous gas mixtures
- Flame arrestor preventing flashbacks
- Thermal cut-off valve prevents excessive temperatures.



IBEDA High Flow Flashback Arrestor with Thermal Cut-Off Valve

Description	Gas	Maximum Air Flow (L/H)	Maximum Pressure (kPa)				Inlet Thread	Outlet Thread	Item Number
			O ₂	Da	LPG	H ₂			
DG 91 N	Fuel	54 700	-	150	500	400	9/16" UNF LH	9/16" UNF LH	W236009
DG 91 N	O ₂	54 700	2 000	-	-	-	9/16" UNF RH	9/16" UNF RH	W236010

IBEDA High Flow Flashback Arrestor with Thermal Cut-Off Valve and Resettable Pressure Gas Cut-Off Valve

This safety device can be used for

- Welding up to 30 mm
- Flame cutting up to 500 mm
- Heating >100 mm.

Safety Features

- Dust inlet filter promoting longer life
- Non-return valve preventing dangerous gas mixtures
- Flame arrestor preventing flashbacks
- Thermal cut-off valve prevents excessive temperatures
- Resettable pressure sensitive gas cut-off valve stops gas flow (Model DS2000).



IBEDA High Flow Flashback Arrestor with Thermal Cut-Off Valve and Resettable Pressure Gas Cut-Off Valve

Description	Gas	Maximum Air Flow (L/H)	Maximum Pressure (kPa)				Inlet Thread	Outlet Thread	Item Number
			O ₂	Da	LPG	H ₂			
DS 2000	Fuel	54 700	-	150	500	400	9/16" UNF LH	9/16" UNF LH	W236037
DS 2000	O ₂	54 700	2 000	-	-	-	9/16" UNF RH	9/16" UNF RH	W236038

Torch Mounted Flashback Arrestors

IBEDA Standard Flashback Arrestor

This safety device can be used for

- Welding up to 30 mm
- Flame cutting up to 200 mm
- Heating up to 50 mm.

Safety Features

- Dust inlet filter promoting longer life
- Non-return valve preventing dangerous gas mixtures
- Flame arrestor preventing flashbacks.



IBEDA Standard Flashback Arrestor

Description	Gas	Maximum Air Flow (L/H)	Maximum Pressure (kPa)				Inlet Connection	Outlet Thread	Item Number
			O ₂	Da	LPG	H ₂			
GT	Fuel	26 300	-	150	500	350	Ø Hose 8 mm	9/16" UNF LH	W236021
GT	O ₂	26 300	2 000	-	-	-	Ø Hose 8 mm	9/16" UNF RH	W236022

IBEDA Standard Flashback Arrestor for Profile Machine Torches

This safety device can be used for

- Welding up to 30 mm
- Flame cutting up to 300 mm
- Heating up to 50 mm.

Safety Features

- Dust inlet filter promoting longer life
- Non-return valve preventing dangerous gas mixtures
- Flame arrestor preventing flashbacks.



IBEDA Standard Flashback Arrestor for Profile Machine Torches

Description	Gas	Maximum Air Flow (L/H)	Maximum Pressure (kPa)				Inlet Thread	Outlet Thread	Item Number
			O ₂	Da	LPG	H ₂			
GG	Fuel	26 300	-	150	500	350	9/16" UNF LH	9/16" UNF LH	W236017
GG	O ₂	26 300	2 000	-	-	-	9/16" UNF RH	9/16" UNF RH	W236018

IBEDA High Flow Flashback Arrestor

This safety device can be used for

- Welding up to 30 mm
- Flame cutting up to 500 mm
- Heating up to 100 mm.

Safety Features

- Dust inlet filter promoting longer life
- Non-return valve preventing dangerous gas mixtures
- Flame arrestor preventing flashbacks.



IBEDA High Flow Flashback Arrestor

Description	Gas	Maximum Air Flow (L/H)	Maximum Pressure (kPa)				Inlet Thread	Outlet Thread	Item Number
			O ₂	Da	LPG	H ₂			
DG 91 UA	Fuel	54 700	-	150	500	400	9/16" UNF LH	9/16" UNF LH	W236013
DG 91 UA	O ₂	54 700	2 000	-	-	-	9/16" UNF RH	9/16" UNF RH	W236014

Regulator Mounted Flashback Arrestors & Quick Release Couplings

IBEDA Standard Flashback Arrestor with Quick Release Couplings

This safety device can be used for

- Welding up to 30 mm
- Flame cutting up to 200 mm
- Heating up to 50 mm.



IBEDA Standard Flashback Arrestor with Quick Release Couplings

Description	Gas	Maximum Air Flow (L/H)	Maximum Pressure (kPa)				Inlet Thread	Outlet Connection	Item Number
			O ₂	Da	LPG	H ₂			
DGN-K + N2	Fuel	32 600	-	150	500	350	9/16" UNF LH	Ø Hose 8 mm	W236088
DGN-K + N2	O ₂	32 600	2 000	-	-	-	9/16" UNF RH	Ø Hose 8 mm	W236089

Torch Mounted Flashback Arrestors & Quick Release Couplings

IBEDA Standard Flashback Arrestor with Quick Release Coupling

This safety device can be used for

- Welding up to 30 mm
- Flame cutting up to 200 mm
- Heating up to 50 mm.

Safety Features

- Dust inlet filter promoting longer life
- Non-return valve preventing dangerous gas mixtures
- Flame arrestor preventing flashbacks
- Thermal cut-off valve prevents excessive temperatures
- Automatic gas cut-off when disconnecting
- Double 'O'-ring seal
- Coloured marking of coupling and pin
- No mixing of gas connections through different coding of pins.



IBEDA Standard Flashback Arrestor

Description	Gas	Maximum Air Flow (L/H)	Maximum Pressure (kPa)				Inlet Connection	Outlet Thread	Item Number
			O ₂	Da	LPG	H ₂			
NKST + N1	Fuel	22 100	-	150	500	350	Ø Hose 8 mm	9/16" UNF LH	W236086
NKST + N1	O ₂	22 100	2 000	-	-	-	Ø Hose 8 mm	9/16" UNF RH	W236087

TRANSARC® GAS EQUIPMENT

The Transarc® NM250 cutting torch is a versatile, well-balanced torch capable of cutting steel up to 270 mm thick. The torch provides excellent flame control and exceptional handling for all industrial cutting applications.

Transarc® NM250 cutting torches feature nozzle mixing technology for added safety and for protecting the torch and operator from accidental backfires.

They can be used with acetylene or LPG, depending on the type of nozzle fitted.

- A** Nozzle mixing helps contain backfires in the nozzle, protecting the torch from downtime and providing added operator safety
- B** Custom angle head design allows for proficient and rapid nozzle change
- C** Large forged head provides unmatched durability and reduces warping for extended service
- D** Three-tube construction keeps gases separate, allowing gas mixing only in the nozzle for added operator safety
- E** Solid lever for added durability
- F** Fully silver-brazed joints, thick-walled stainless steel tubes and solid brass forged head and tail result in robustness and lower maintenance costs
- G** Easy-grip valves give you full control over your cutting flame
- H** Heavy duty cast handle for positive grip, comfort and control
- I** Colour coded control knobs to improve operator productivity and safety



1 year conditional warranty
ISO 5172 TÜV certified

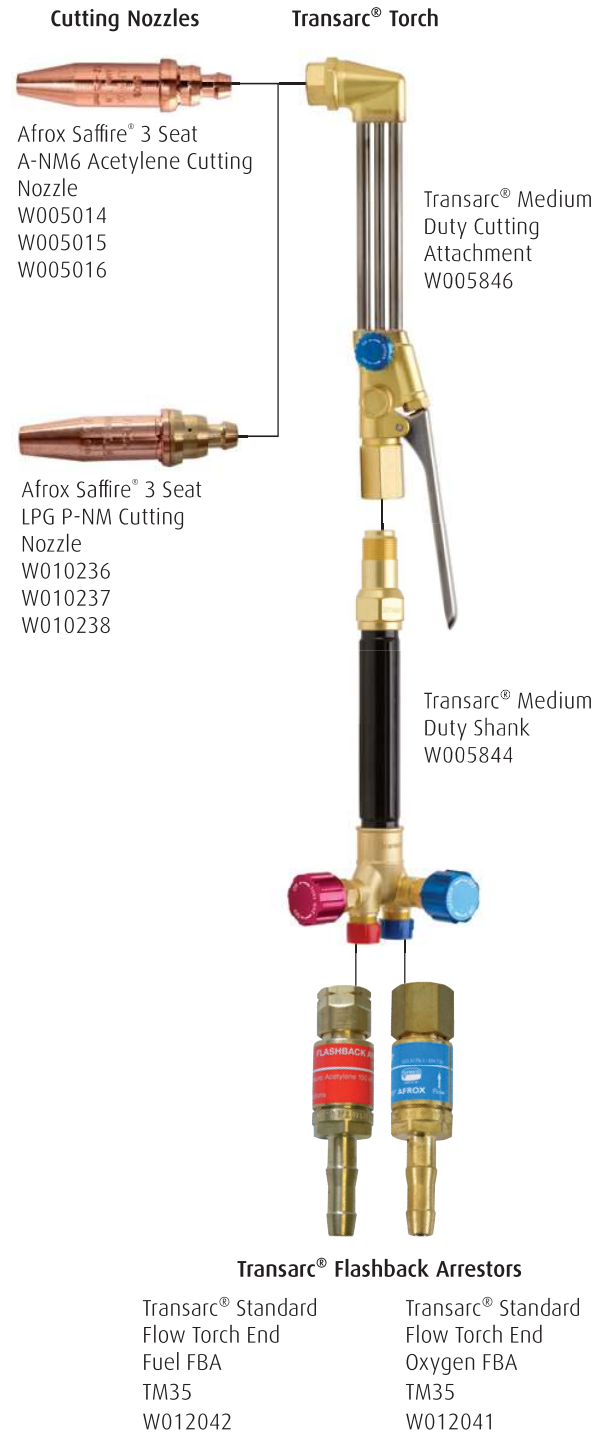

Afrox Saffire® Welding Nozzles*

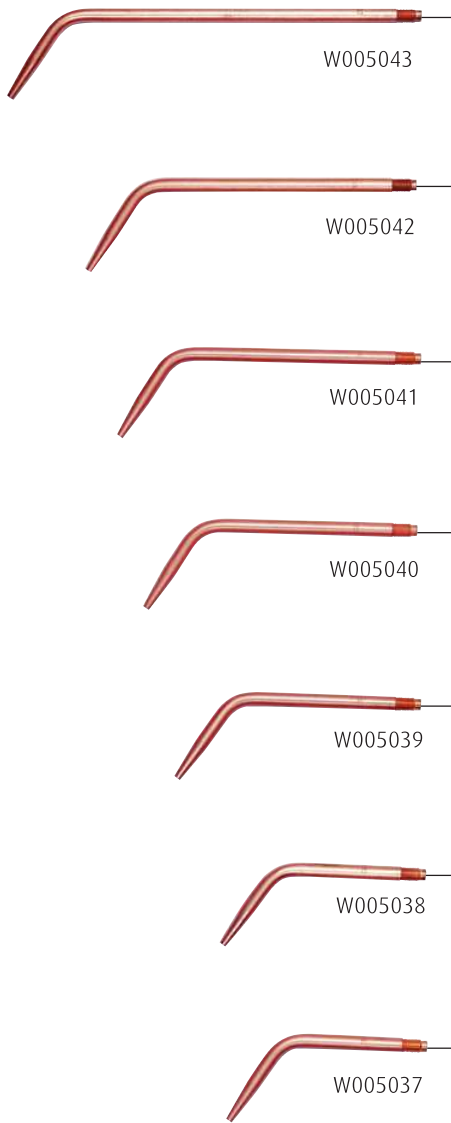

Afrox Saffire® Type 2 Mixer



Transarc® Medium Duty Shank



Transarc® Flashback Arrestors

Transarc® Standard
Flow Torch End
Fuel FBA
TM35
W012042

Transarc® Standard
Flow Torch End
Oxygen FBA
TM35
W012041

For Your Safety:
Use flashback arrestors on both ends (regulator and torch).

Transarc® Regulator Series

The Transarc® series comprises a range of versatile pressure regulators designed to offer a safe and reliable product. The range is ISO 2503 certified and each regulator has been designed to provide optimum flow control utilising Afrox's patented Quadflow encapsulated valve technology. The product has been designed to the latest and most stringent regulatory standards to offer an extended product life.

Features

- 3rd generation Quadflow technology encapsulated valve
- 62 mm gauges colour-coded for ease of use and setting
- Full technical and back up service from Afrox
- 1 year conditional warranty.



Afrox Transarc® Single-Stage Regulator

Model	Description	Gas Type	Delivery Pressure	Inlet Connection	Outlet Connection	Max Inlet Pressure	Item Number
S6000 AGS 150	Single-stage general-purpose regulator for welding, cutting and heating	Acetylene	0 - 150 kPa	5/8" LH	3/8" LH	2 750 kPa	W003858
S6000 OGS 600	Single-stage medium outlet pressure regulator for medium duty welding and cutting	Oxygen	0 - 600 kPa	5/8" RH	3/8" RH	30 000 kPa	W003859
S6000 LGS 400	Single-stage 400 kPa Handigas (LPG) regulator suitable for the full range of Afrox LPG nozzles	Handigas (LPG)	0 - 400 kPa	5/8" LH	3/8" LH	2 000 kPa	W003612

Transarc® Flashback Arrestors

Afrox Transarc® Flashback Arrestors

Model	Gas	Inlet Connection	Outlet Connection	Description	Item Number
Transarc® TM35	Fuel Gas	8 mm Hose	3/8" BSP	Torch Mount	W012042
Transarc® TM35	Oxygen	8 mm Hose	3/8" BSP	Torch Mount	W012041
Transarc® RM35	Fuel Gas	8 mm Hose	3/8" BSP	Regulator Mount	W012037
Transarc® RM35	Oxygen	8 mm Hose	3/8" BSP	Regulator Mount	W012036





It's all good **when portability is key**

The Afrox PortaPak is light and robust making it ideal to take your cutting and brazing skills anywhere. This mobile one-of-a-kind unit is perfect for one-man operations where portability is vital.

Africa's leading gases and welding solutions partner

Customer Service Centre: 0860 020202

Shop online: www.afroxshop.co.za

www.afrox.co.za



 **AFROX**
A Linde company

