

# ARC EQUIPMENT & PROCESSES

**Section 8 - Arc Equipment & Processes 232****Welding Processes 234**

MMA Process 234

MIG Process 235

TIG Process 239

Submerged Arc Welding (SAW) 241

Welding Process Comparisons 242

Welding Power Sources 244

Welding Power Source Comparisons 247

**Arc Equipment 248**

Afrox Industrial Range 248

MIG Power Sources 249

TIG Power Sources 251

MMA Power Sources 253

Multiprocess Power Sources 255

Afrox Transarc® Range 256

Plasma Power Sources 257

Miller Range 258

MIG Packages 258

TIG Power Sources 260

MMA Power Sources 263

Multiprocess Power Sources 265

Engine Driven Power Sources 267

Miller Spectrum Plasma Cutting Power Sources 270

Genuine Miller Accessories 271

Miller Wire Feeders 271

Remote Controls 272

Optional Extras 272

Afrox Voltage Reducers 273

MIG Torches &amp; Consumables 274

General Consumables - MIG Torches 280

TIG Torches &amp; Consumables 283

New GYS Plasma Range 285

Plasma Power Sources 285

Plasma Torches &amp; Consumables 288

Afrox Arc Equipment – RENT OR BUY? 290

**View the following videos:**

- SHIELDED METAL ARC WELDING
- PORTAMIG 180P
- AFROX MIG SET-UP AND MAINTENANCE
- AFROX (TIG) PRINCIPLES OF GAS TUNGSTEN ARC WELDING
- AFROX (MMA) PRINCIPLES OF GAS METAL ARC WELDING AND FLUX CORED ARC WELDING

on 

# WELDING PROCESSES

## MMA Process

Manual Metal Arc (MMA) welding is an electric arc welding process in which the arc is struck between a covered metal electrode and the workpiece. The central metal electrode or core wire is consumable to provide the filler metal for the weld. Shielding of the weld pool is provided by the decomposition of some components of the electrode covering.

- MMA welding is the most flexible and one of the most widely used arc welding processes
- The process uses an electric arc to fuse joint areas
- The consumable electrode consists of a metal core wire covered in a concentric clay-like mixture
- The process may be operated with an AC or DC power source
- This process requires highly skilled welders to produce good quality welds
- The process does not require a separate shielding gas.

Engine driven generators can be used in the field as well as in the workshop, and in remote areas where mains power is not available, thereby extending MMA welding's versatility.

With MMA welding, only a limited amount of weld metal can be deposited from one electrode. This means electrodes have to be replaced frequently, making it a less productive process than other welding methods.

### Operation

MMA is a fusion welding process that uses the heat generated by an electric arc to fuse metal in the joint area, the arc being struck between a covered consumable electrode and the workpiece.

The process consists of a welding power source that may provide either an AC, DC or DC and AC electric current. Connected to this power source is an electrode holder into which the electrode is placed. The circuit is completed with an earth return cable fixed between the power source and the workpiece.

When the arc is struck between the tip of the electrode and the workpiece, the core wire begins to melt, and the coating provides a protective gas and slag covering to the weld.

As the core wire melts, the operator must maintain a constant arc length – distance between the end of the electrode and the workpiece – to prevent the arc extinguishing. Parent metal in the immediate area of the arc is also melted and this combines with molten metal from the electrode to form a weld pool.

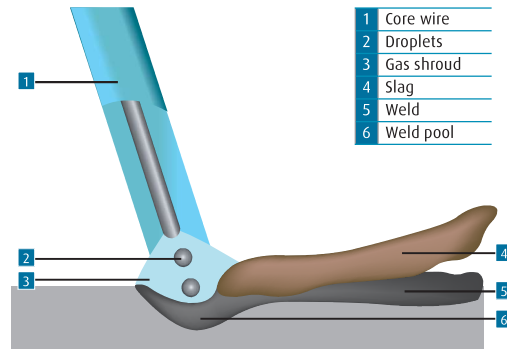

Schematic of MMA process in operation

### Applications

The MMA process can be used to weld:

- Most steels
- Stainless steels
- Cast irons
- Nickel alloys
- Copper alloys
- Aluminium alloys.

MMA welding is also used for hardfacing, and for gouging, cutting and grooving of ferritic alloys.

Applications for MMA are many and varied:

- General fabrication
- Structural steelwork
- Power plant
- Process plant
- Pressure vessels
- Cryogenic plant
- Pipelines
- Shipbuilding
- Bridge-building
- Offshore fabrication
- Repair and maintenance in a wide variety of industries.

MMA is particularly suited to site and external welding applications such as the repair of agricultural equipment.

### MMA Welding Equipment

The equipment used for MMA welding consists of:

- Power source
- Electrode cable
- Electrode holder
- Electrode
- Work clamp
- Return cable.

Whether you work with MIG/MAG welding machines, TIG/MMA welders or plasma machines, Afrox offers a unique and extensive range of arc equipment. From basic DIY welders to advanced capabilities and superior functionality, to lightweight portable plasma cutting systems, Afrox gives you unprecedented choice and quality. With a full complement of accessories, spares and welding consumables, the professional welder has everything at hand from a single and trusted supplier.

# MIG Process

## Gas Metal Arc Welding (GMAW)

GMA – commonly referred to as Metal Inert Gas (MIG) – welding embraces a group of arc welding processes in which a continuous electrode (the wire) is fed by powered feed rolls (wire feeder) into the weld pool. An electric arc is created between the tip of the wire and the weld pool. The wire is progressively melted at the same speed at which it is being fed and forms part of the weld pool. Both the arc and the weld pool are protected from atmospheric contamination by a shield of inert (non-reactive) gas, which is delivered through a nozzle that is concentric with the welding wire guide tube.

### Operation

MIG welding is usually carried out with a handheld gun as a semi-automatic process. The MIG process can be suited to a variety of job requirements by choosing the correct shielding gas, electrode (wire) size and welding parameters. Welding parameters include the voltage, travel speed, arc (stick out) length and wire feed rate. The arc voltage and wire feed rate will determine the filler metal transfer method.

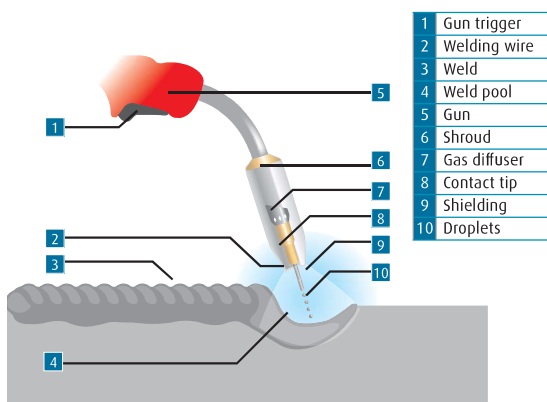

This application combines the advantages of continuity, speed, comparative freedom from distortion and the reliability of automatic welding with the versatility and control of manual welding. The process is also suitable for mechanised set-ups, and its use in this respect is increasing.

MIG welding can be carried out using solid wire, flux cored, or a copper-coated solid wire electrode. The shielding gas or gas mixture may consist of the following:

- Argon
- Carbon dioxide
- Argon and carbon dioxide mixtures
- Argon mixtures with oxygen or helium mixtures.

Afrox recommends Afrox shielding gas mixtures.

Each gas or gas mixture has specific advantages and limitations. Other forms of MIG welding include using a flux cored continuous electrode and carbon dioxide shielding gas, or using self-shielding flux cored wire, requiring no shielding.

## Flux Cored Arc Welding (FCAW)

### How It Works

Flux Cored Arc Welding (FCAW) uses the heat generated by a DC electric arc to fuse the metal in the joint area, the arc being struck between a continuously fed consumable filler wire and the workpiece, melting both the filler wire and the workpiece in the immediate vicinity. The entire arc area is covered by a shielding gas that protects the molten weld pool from the atmosphere.

FCAW is a variant of the MIG process and, while there are many common features between the two processes, there are also several fundamental differences.

As with MIG, direct current power sources with constant voltage output characteristics are normally employed to supply the welding current. With flux cored wires, the terminal that the filler wire is connected to depends on the specific product being used (some wires run electrode positive and others run electrode negative). The work return is then connected to the opposite terminal. It has also been found that the output characteristics of the power source can have an effect on the quality of the welds produced.

The wire feed unit takes the filler wire from a spool, and feeds it through the welding gun, to the arc at a predetermined and accurately controlled speed. Normally, special knurled feed rolls are used with flux cored wires to assist feeding and to prevent crushing the consumable.

Unlike MIG, which uses a solid consumable filler wire, the consumable used in FCAW is of tubular construction, an outer metal sheath being filled with fluxing agents plus metal powder. The flux fill is also used to provide alloying, arc stability, slag cover, de-oxidation and, with some wires, gas shielding.

In terms of gas shielding, there are two different ways in which this may be achieved with the FCAW process:

- Additional gas shielding supplied from an external source, such as a gas cylinder
- Production of a shielding gas by decomposition of fluxing agents within the wire (self-shielding).

Gas shielded wires are available with either a basic or rutile flux fill, while self-shielded wires have a broadly basic type flux fill. The flux fill dictates the way the wire performs, the properties obtainable, and suitable applications.

### Gas Shielded Operation

Many cored wire consumables require an auxiliary gas shield in the same way that solid wire MIG consumables do. These types of wire are generally referred to as 'gas shielded'.

Using an auxiliary gas shield enables the wire designer to concentrate on the performance characteristics, process tolerance, positional capabilities and mechanical properties of the products.

In a flux cored wire, the metal sheath is generally thinner than that of a self-shielded wire. The area of this metal sheath surrounding the flux cored wire is much smaller than that of a solid MIG wire. This means that the electrical resistance within

the flux cored wire is higher than with solid MIG wires and it is this higher electrical resistance that gives this type of wire some of its novel operating properties.

One often quoted property of flux cored wires is their higher deposition rates in comparison to solid MIG wires. What is often not explained is how they deliver these higher values and whether these can be utilised. For example, if a solid MIG wire is used at 250 A, then exchanged for a flux cored wire of the same diameter, and welding power source controls are left unchanged, then the current reading would be much less than 250 A, and perhaps as low as 220 A. This is because of Ohm's Law, which states that as the electrical resistance increases (and if the voltage remains stable) then the current must fall.

To bring the welding current back to 250 A, it is necessary to increase the wire feed speed, effectively increasing the amount of wire being pushed into the weld pool to make the weld. It is this effect that produces the 'higher deposition rates' that the flux cored wire manufacturers claim for this type of product. Unfortunately, in many instances, the welder has difficulty in utilising this higher wire feed speed and must either increase the welding speed or increase the size of the weld. Often in manual applications, neither of these changes can be implemented and the welder simply reduces the wire feed speed back to where it was and the advantages are lost. However, if the process is automated in some way, then the process can show improvements in productivity.

It is also common to use longer contact tip to workplace distances with flux cored arc welding than with solid wire MIG welding, which has the effect of increasing the resistive heating on the wire further accentuating the drop in welding current. Research has also shown that increasing this distance can lead to an increase in the ingress of nitrogen and hydrogen into the weld pool, which can affect the quality of the weld.

Flux cored arc welding has a lower efficiency than solid wire MIG welding, because part of the wire fill contains slag forming agents. Although the efficiency varies by wire type and manufacturer, it is typically between 75 and 85%.

Flux cored arc welding does, however, have the same drawback as solid wire MIG in terms of gas disruption by wind, and screening is always necessary for site work. It also incurs the extra cost of shielding gas, but this is often outweighed by gains in productivity.

### Self-Shielded Operation

There are also self-shielded consumables designed to operate without an additional gas shield. In this type of product, arc shielding is provided by gases generated by decomposition of some constituents within the flux fill. These types of wire are referred to as 'self-shielded'.

If no external gas shield is required, then the flux fill must provide sufficient gas to protect the molten pool and to provide de-oxidisers and nitride formers to cope with atmospheric contamination. This leaves less scope to address performance, arc stabilisation and process tolerance, so these tend to suffer when compared with gas shielded types.

Wire efficiencies are also lower, at about 65%, in this mode of operation than with gas shielded wires. However, the wires do have a distinct advantage when it comes to site work in terms of wind tolerance, as there is no external gas shield to be disrupted.

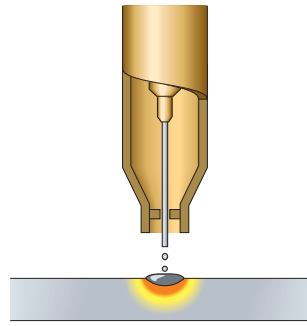

Extended self-shielded flux cored wire nozzle

When using self-shielded wires, external gas supply is not required and, therefore, the gas shroud is not necessary. However, an extension nozzle is often used to support and direct the long electrode extensions that are needed to obtain high deposition rates.

## Metal Cored Arc Welding (MCAW)

### How It Works

Metal Cored Arc Welding (MCAW) uses the heat generated by a DC electric arc to fuse metal in the joint area, the arc being struck between a continuously fed consumable filler wire and the workpiece, melting both the filler wire and the workpiece in the immediate vicinity. The entire arc area is covered by a shielding gas, which protects the molten weld pool from the atmosphere.

As MCAW is a variant of the MIG welding process, there are many common features between the two processes, but there are also several fundamental differences.

As with MIG, direct current power sources with constant voltage output characteristics are normally employed to supply the welding current. With metal cored wires, the terminal that the filler wire is connected to depends on the specific product being used. (Some wires are designed to run on electrode positive, while others run on electrode negative, and some run on either.) The work return lead is then connected to the opposite terminal. Electrode negative operation will usually give better positional welding characteristics. The output characteristics of the power source can have an effect on the quality of the welds produced.

The wire feed unit takes the filler wire from a spool or bulk pack, and feeds it through the welding gun to the arc at a predetermined and accurately controlled speed. Normally, special knurled feed rolls are used with metal cored wires to assist feeding and to prevent crushing the consumable.

Unlike MIG, which uses a solid consumable filler wire, the consumable used in MCAW is of tubular construction, an outer metal sheath being filled entirely with metal powder, except for a small amount of non-metallic compounds. These are added to provide some arc stability and de-oxidation.

MCAW consumables always require an auxiliary gas shield in the same way that solid MIG wires do. Wires are normally designed to operate in argon-carbon dioxide or argon-carbon dioxide-oxygen mixtures or carbon dioxide. Argon-rich mixtures tend to produce lower fume levels than carbon dioxide.

As with MIG, the consumable filler wire and the shielding gas are directed into the arc area by the welding gun. In the head of the gun, the welding current is transferred to the wire by means of a copper alloy contact tip, and a gas diffuser distributes the shielding gas evenly around a shroud which then allows the gas to flow over the weld area. The position of the contact tip relative to the gas shroud may be adjusted to limit the minimum electrode extension.

Modes of metal transfer with MCAW are very similar to those obtained in MIG welding, the process being operable in both 'dip transfer' and 'spray transfer' modes. Metal cored wires may also be used in pulse transfer mode at low mean currents, but this has not been widely exploited.

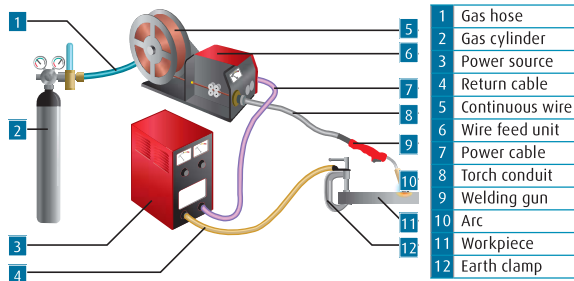

Process schematic diagram for MIG/FCAW and MCAW

### Modes of Metal Transfer

The mode or type of metal transfer in MIG welding depends upon the current, arc voltage, electrode diameter and type of shielding gas used. In general, there are four modes of metal transfer.

Modes of metal transfer with FCAW are similar to those obtained in MIG welding, but here the mode of transfer is heavily dependent on the composition of the flux fill, as well as on current and voltage.

The most common modes of transfer in FCAW are:

- Dip transfer
- Globular transfer
- Spray transfer.

Pulsed arc transfer operation has been applied to flux cored wires but, as yet, is not widely used because the other transfer modes are giving users what they require in most cases.

### Dip Transfer

Also known as short-circuiting arc or short-arc, this is an all-positional process, using low heat input. The use of relatively low current and arc voltage settings cause the electrode to intermittently short-circuit with the weld pool at a controlled frequency. Metal is transferred by the wire tip actually dipping into the weld pool and the short-circuit current is sufficient to allow the arc to be re-established. This short-circuiting mode of metal transfer effectively extends the range of MIG welding to lower currents so thin sheet material can readily be welded. The low heat input makes this technique well-suited to the positional welding of root runs on thick plate, butt welds for bridging over large gaps and for certain difficult materials where heat input is critical. Each short-circuit causes the current to rise and the metal fuses off the end of the electrode. A high short-circuiting frequency gives low heat input. Dip transfer occurs between  $\pm 70$ – $220$  A, 14–23 arc volts. It is achieved using shielding gases based on carbon dioxide and argon.

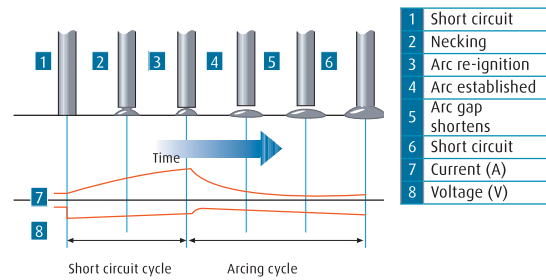

Schematic of dip transfer

Metal cored wires transfer metal in dip mode at low currents, just like solid MIG wires. This transfer mode is used for all positional work with these types of wire.

### Globular Transfer

Metal transfer is controlled by slow ejection, resulting in large, irregularly-shaped 'globs' falling into the weld pool under the action of gravity. Carbon dioxide gas drops are dispersed haphazardly. With argon-based gases, the drops are not as large and are transferred in a more axial direction. There is a lot of spatter, especially in carbon dioxide, resulting in greater wire consumption, poor penetration and poor appearance. Globular transfer occurs between the dip and spray ranges. This mode of transfer is not recommended for normal welding applications and may be corrected when encountered by either decreasing the arc voltage or increasing the amperage. Globular transfer can take place with any electrode diameter.

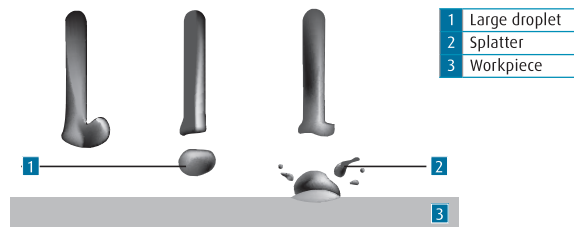

Schematic formation of globular transfer

Basic flux cored wires tend to operate in a globular mode or in a globular-spray transfer mode, where larger than normal spray droplets are propelled across the arc, but they never achieve a true spray transfer mode. This transfer mode is sometimes referred to as non-axial globular transfer.

Self-shielded flux cored wires operate in a predominantly globular transfer mode, although at high currents the wire often 'explodes' across the arc.

### Spray Transfer

In spray transfer, metal is projected by an electromagnetic force from the wire tip in the form of a continuous stream of discrete droplets approximately the same size as the wire diameter. High deposition rates are possible and weld appearance and reliability are good. Most metals can be welded, but the technique is limited generally to plate thicknesses greater than 6 mm. Spray transfer, due to the tendency of the large weld pool to spill over, cannot normally be used for positional welding. The main exception is aluminium and its alloys where, primarily because of its low density and high thermal conductivity, spray transfer in position can be carried out.

The current flows continuously because the high voltage maintains a long arc and short-circuiting cannot take place. It occurs best with argon-based gases.

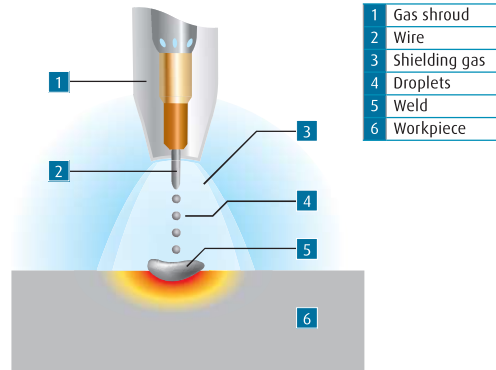

Schematic of spray transfer

In solid wire MIG, as the current is increased, dip transfer passes into spray transfer via a transitional globular transfer mode. With metal cored wires there is virtually a direct transition from dip transfer to spray transfer as the current is increased.

For metal cored wire, spray transfer occurs as the current density increases and an arc is formed at the end of the filler wire, producing a stream of small metal droplets. Often the outside sheath of the wire will melt first and the powder in the centre flows as a stream of smaller droplets into the weld pool. This effect seems to give much better transfer of alloying elements into the weld.

In spray transfer, as the current density increases, an arc is formed at the end of the filler wire, producing a stream of small metal droplets. In solid wire MIG, this transfer mode occurs at higher currents. Flux cored wires do not achieve a completely true spray transfer mode, but a transfer mode that is almost true spray may occur at higher currents and can occur at relatively low currents depending on the composition of the flux.

Rutile flux cored wires will operate in this almost-spray transfer mode at all practicable current levels. They are also able to operate in this mode for positional welding. Basic flux cored and self-shielded flux cored wires do not operate in anything approaching true spray transfer mode.

### Pulsed Transfer

Pulsed arc welding is a controlled method of spray transfer, using currents lower than those possible with the spray transfer technique, thereby extending the applications of MIG welding into the range of material thickness where dip transfer is not entirely suitable. The pulsed arc equipment effectively combines two power sources into one integrated unit. One side of the power source supplies a background current which keeps the tip of the wire molten. The other side produces pulses of a higher current that detach and accelerate the droplets of metal into the weld pool. The transfer frequency of these droplets is regulated primarily by the relationship between the two currents. Pulsed arc welding occurs between  $\pm 50$ – $220$  A,  $23$ – $35$  arc volts, and only with argon and argon-based gases. It enables welding to be carried out in all positions.

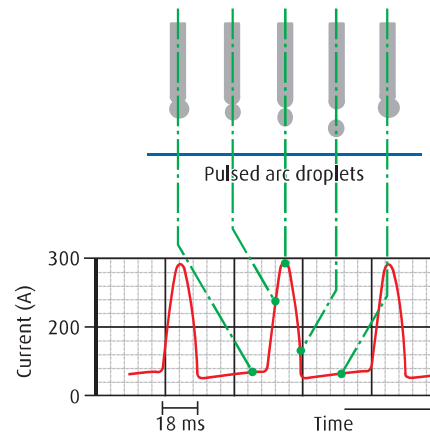

Schematic of pulse transfer

Process	Dip Transfer	Globular Transfer	Spray Transfer	Pulsed Transfer
Metal Inert Gas (MIG)	●		●	●
Flux Cored (Rutile Type)	●	●	Not True Spray	
Flux Cored (Basic Type)	●	●		
Metal Cored	●		●	●

# TIG Process

The Gas Tungsten Arc Welding – commonly referred to as Tungsten Inert Gas (TIG) – process uses the heat generated by an electric arc struck between a non-consumable tungsten electrode and the workpiece to fuse metal in the joint area and produce a molten weld pool. The arc area is shrouded in an inert or reducing gas shield to protect the weld pool and the non-consumable electrode. The process may be operated autogenously (without filler), or filler may be added by feeding a consumable wire or rod into the established weld pool.

- The addition of filler is optional
- Only inert or reducing gases can be used as the shielding gas
- TIG welding is a high quality, versatile and commonly used process
- TIG is suitable for welding ferrous and non-ferrous materials
- The TIG process can be run on DC-, DC+, or AC.

The TIG process is capable of producing very high quality welds in a wide range of materials and in thicknesses up to about 8 or 10 mm. It is particularly suited to welding of sheet material and for putting in the root run of pipe butt welds.

The process tends to be very clean, producing little particulate fume, although it is capable of generating ozone in appreciable amounts and is not regarded as a high-productivity process.

## Operation

Direct or alternating current power sources with constant current output characteristics are normally employed to supply the welding current. For DC operation, the tungsten may be connected to either output terminal, but is most often connected to the negative pole. The output characteristics of the power source can have an effect on the quality of the welds produced. Shielding gas is directed into the arc area by the welding torch, and a gas lens within the torch distributes the shielding gas evenly over the weld area. In the torch, the welding current is transferred to the tungsten electrode from the copper conductor. The arc is then initiated by one of several methods between the tungsten and the workpiece.

## Operating Modes

The TIG process may be operated in one of the following modes:

- Direct Current Electrode Negative (DCEN)
- Direct Current Electrode Positive (DCEP)
- Alternating Current (AC).

The mode used is largely dependent on the parent material being welded.

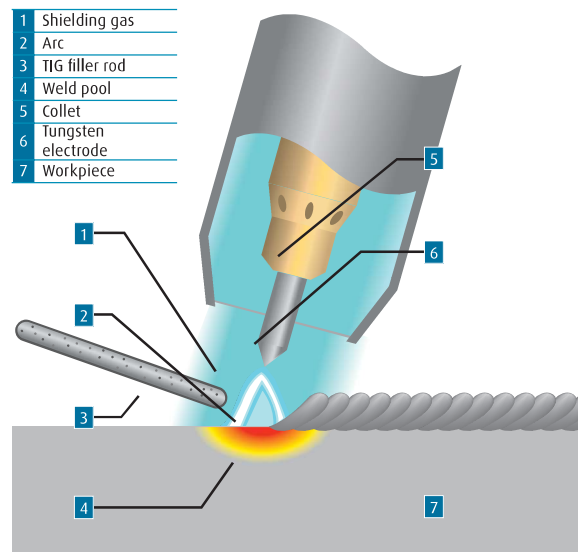

Schematic of the TIG welding process

## DC Electrode Negative (DCEN)

In this mode the tungsten electrode is the negative pole in the welding circuit, the workpiece being the positive pole.

## DC Electrode Positive (DCEP)

In this mode the tungsten electrode is the positive pole in the welding circuit, the workpiece being the negative pole.

## Alternating Current (AC)

In this mode the polarity of the tungsten electrode and the workpiece alternate between negative and positive at the frequency of the applied welding current.

## Process Variants

There are three main variations of the TIG process designed to improve productivity:

- Orbital TIG
- Hot-wire TIG
- Narrow-gap TIG
- Cold-wire TIG.

## Application

The TIG process is very versatile and may be used to weld any metal or alloy system over a wide range of thicknesses, but is usually restricted to 10 mm and under for economic reasons. It is particularly suited to welding sheet materials and for the root run in pipe butt welds.

**DCEN** is the most common mode of operation and is widely used for welding all carbon, alloy and stainless steels, as well as nickel and titanium alloys. Copper alloys, with the exception of those containing aluminium in significant amounts, can also be welded with this polarity.



**DCEP** is used for aluminium alloys when welding, with pure helium as the shielding gas, since this polarity has a strong cathodic cleaning effect capable of removing the tenacious aluminium oxide film from the surface. It may also be used for TIG welding magnesium alloys.

**AC** polarity is used most commonly when welding aluminium and its alloys with pure argon or argon-helium mixtures to take advantage of the combination of the cyclic heating and cleaning action. It is also suitable for welding magnesium alloys and aluminium bronze.

**Hot-wire TIG** is used predominantly for steel and nickel alloys where the electrical resistance of the wire can be used to increase productivity.

#### Applications

- High quality fabrications in stainless steel
- Aluminium, copper and nickel alloys
- Welding reactive and refractory metals such as titanium, tantalum and zirconium.

The process is used extensively in the nuclear and aerospace industries and in the construction and maintenance of chemical and cryogenic process plant and pipework. It is also used

for fabrication of tube heat exchangers in petrochemical and power-generation plant, and for brewing and food-processing vessels.

**Orbital TIG** welding is used in the nuclear, pharmaceutical, semi-conductor and food industries for the installation of pipework – especially where high quality standards are required.

Specialist equipment for tube and tube-plate welding for heat exchangers has been developed. These systems may operate from the outside or inside, depending on tube diameter and the size of the welding head.

#### TIG Welding Equipment

The equipment used for TIG welding consists of:

- Power source
- Welding torch
- Tungsten electrode
- Leads and connectors
- Gas supply system
- Arc and re-ignition system.

# Submerged Arc Welding (SAW)

## How It Works

SAW uses the arc struck between a continuously fed electrode and the workpiece to melt the metal in the joint area and provide additional filler metal under a blanket of granular flux. This arc is completely submerged under the molten flux, which protects the molten metal from the atmosphere. There is no visible arc, spatter or fume during the welding operation. The continuous electrode can be a solid or cored wire.

The solid wires are normally copper coated. The cored wires may contain either metallic materials or a mixture of metallic and flux materials. Flux cored wires affect the welding characteristics and metallurgical quality of the deposited weld metal. On surfacing applications, a strip electrode can be used instead of a wire.

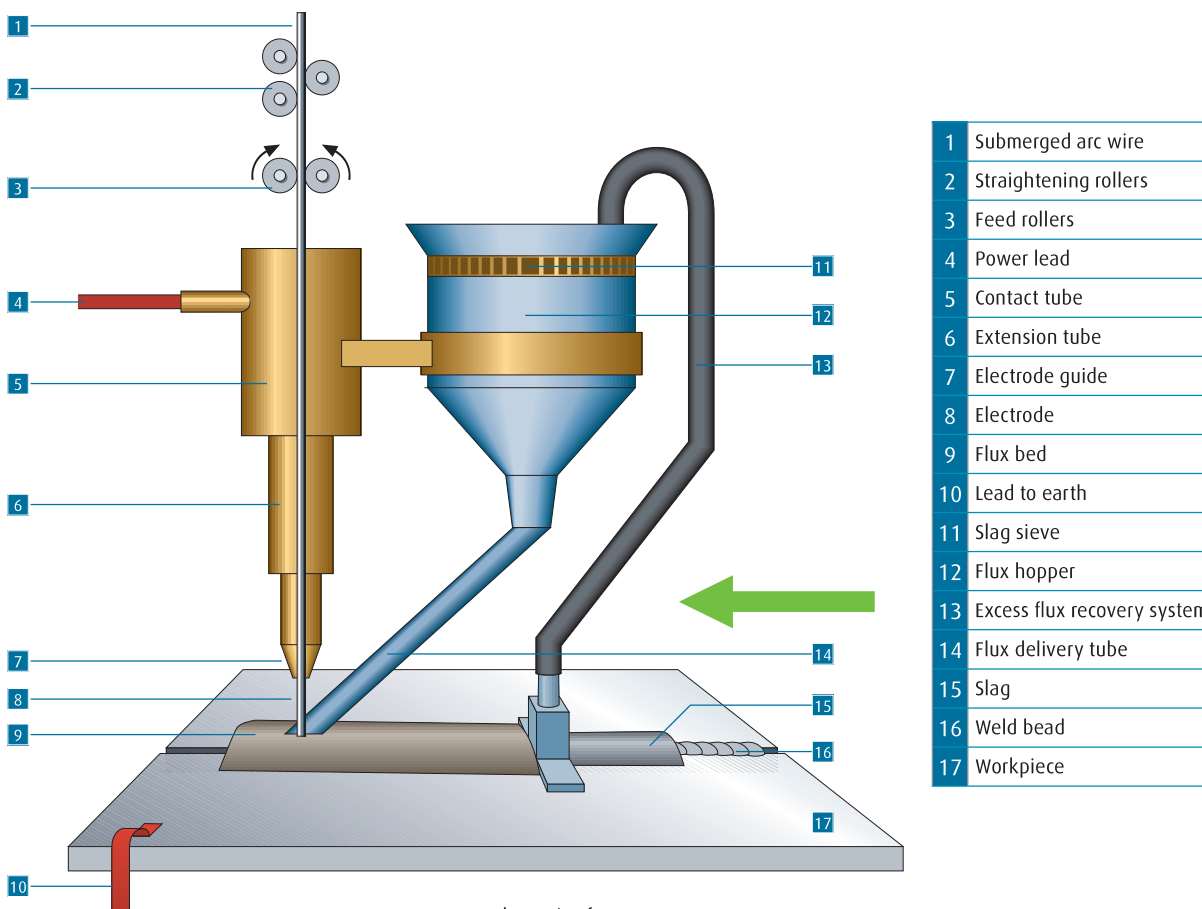

Schematic of SAW process

A wide range of flux compositions is used with submerged arc welding. Generally speaking, fluxes with the best welding characteristics give inferior weld metal mechanical properties. These fluxes are known as acid fluxes. Neutral fluxes generally give a good all round performance. While basic fluxes give the best metallurgical results, they possess inferior welding characteristics. The normal approach is to select the flux with the best running characteristics that will meet the metallurgical requirements comfortably.

SAW may be carried out using either DC or AC power sources. The best all round welding conditions are normally obtained with DC electrode positive. DC electrode negative will give higher deposition rates, but fusion characteristics are reduced so that this mode of transfer is mainly used on weld surfacing applications. AC welding may also be used, but arc control is not as good as on DC electrode positive. This means that many fluxes are developed primarily for DC operation and will not operate satisfactorily on AC.

## Operating Parameters

SAW is capable of operating at high welding currents. Welding current is the parameter that controls weld deposition rate. It also controls the depth of weld penetration and the amount of base metal melted. Arc voltage controls the arc length and this has a major influence on the shape of the weld and its exterior appearance. Raising the arc voltage increases the arc length and this, in turn, increases the weld width. Lowering the arc voltage has the opposite effect.

The travel speed controls the heat input into the joint area. Increasing travel speed reduces the heat input and supplies less filler metal per unit length of weld, resulting in less weld reinforcement. Increasing travel speed reduces weld penetration but can cause undercut. Reducing travel speed provides time for the gases to escape from the molten metal and thus porosity may be reduced.

Electrode 'stick out', the distance between the contact tube and the arc, has a major affect on weld penetration and deposition rate. Increasing the stick out increases deposition rate and reduces weld penetration. However, to maintain optimum process control, the electrode stick out is normally maintained between 25–35 mm unless special nozzle adaptors are fitted.

### Application

SAW is widely used for welding carbon, carbon manganese, alloy and stainless steels. It is also used for joining some nickel based alloys.

The ability to produce high quality, defect-free welds at high deposition rates and with deep weld penetration makes the SAW process highly suitable for all mechanised and automatic welding and surfacing applications.

### Typical Welding Applications

With welding longitudinal and spiral welded pipes, the longitudinal welds are carried out using a two-pass welding procedure. A welding station located inside the pipe deposits the inside weld and the joint is completed by another station with a single weld on the outside of the pipe. Spiral welded pipes are produced from a continuous coil of strip that is folded into a spiral. One welding head deposits a single weld on the inside and another completes the joint from the outside.

In shipbuilding, the process is used to produce butt welds with a two pass welding procedure depositing a single run on each side of the joint. Stiffeners are produced using single and twin fillet welding procedures. Major shipyards carry out this operation using panel lines where large sections are produced prior to transfer to the construction berth.

Submerged arc welding is widely used on general structural steel welding applications, including mass production of repetitive short welds. Single side welding procedures using a copper backing system are often used on applications such as propane cylinder production.

### Typical Surfacing Applications

Roll resurfacing is carried out as a continuous operation. Circumferential bead welds are deposited on the roll surface. When a weld is completed around the roll, the welding head is automatically adjusted to produce the next bead adjacent to the previous one. This process is continued until the complete roll has received one layer of surfacing deposit. The head is then repositioned to produce a second and further layers of weld metal as required.

Submerged arc welding is widely used for cladding carbon and alloy steels with stainless steel and nickel alloy deposits. This process is usually carried out using strip electrodes and alloy bearing fluxes which compensate for alloy losses in the arc.

**Afrox offers a range of accessories for submerged arc welding.**

## Welding Process Comparisons

Weld costs, productivity, weld positions, weld materials and welder skill are all criteria to be considered when selecting welding processes and their appropriate equipment and consumables. These factors will significantly affect the quality of the weld and the overall process costs.

### MMA Comparisons

#### MIG to MMA

- MMA is an intermittent, low-productivity process with electrode replacement necessary at regular intervals
- MMA is predominantly a manual process, whereas MIG can be used manually, automatically and robotically
- MMA electrodes are available primarily for ferrous materials and nickel alloys, but electrodes can be tailored to suit the composition of the parent material. MIG covers a wider range of standard materials, but all grades are not always available
- MMA requires no shielding gas
- MMA is ideally suited to outside and site work; MIG suffers from draughts affecting the gas shield
- Consumable wastage levels in MMA are high
- MMA requires the slag to be removed, as MIG doesn't create a slag cover

- Welding speeds are much quicker with MIG, so joint completion times are much lower
- With MMA, only about 65% of the consumable weight is converted into weld metal, compared to about 98% for MIG.

#### TIG to MMA

- MMA is predominantly a manual process, but TIG is used both manually and for the automatic orbital welding of pipe
- MMA electrodes are available primarily for ferrous materials and nickel alloys, but electrodes can be tailored to suit the composition of the parent material. TIG covers a wide range of both ferrous and non-ferrous materials
- MMA requires no shielding gas
- MMA is ideally suited to outside and site work, while TIG suffers from draughts affecting the gas shield
- Consumable wastage levels in MMA are high
- MMA requires the slag to be removed, as TIG doesn't create a slag cover
- Welding speeds are higher with MMA, but with clean-up added there can be little difference between the processes
- TIG welding power sources are normally capable of being used for MMA welding

- Both processes require good operator technique to produce high quality welds.

#### FCAW to MMA

- MMA is predominantly a manual process, whereas FCAW can be used manually, automatically and robotically
- MMA electrodes and flux cored wires cover very similar ferrous, nickel and hardfacing materials
- MMA requires no shielding gas. Some types of cored wire require a shielding gas but others don't
- MMA is ideally suited to outside and site work, as are gasless cored wires
- Consumable wastage levels in MMA are high compared to cored wires
- Welding speeds are much quicker with cored wires, so joint completion times are much faster
- With MMA, only about 65% of the consumable weight is converted into weld metal, compared to about 80% for FCAW.

## MIG Comparisons

#### MMA to MIG

- MIG is a high-productivity continuous process requiring little downtime
- MIG can be used manually, automatically and robotically, whereas MMA is predominantly a manual process
- MIG covers a wide range of standard materials. MMA electrodes are available primarily for ferrous materials and nickel alloys, but electrodes can be tailored to suit the composition of the parent material
- MIG requires a shielding gas, which is often different for different materials. MMA requires no shielding gas
- MIG suffers from draughts affecting the gas shield. MMA is ideally suited to outside and site work because it doesn't require a shielding gas
- There is little wastage associated with MIG welding. Consumable wastage levels in MMA are high
- MIG doesn't create a slag cover, but MMA requires the slag to be removed
- Welding speeds are much quicker with MIG, so joint completion times are much lower
- With MIG, about 98% of the consumable weight is converted into weld metal compared to about 65% for MMA.

#### TIG to MIG

- MIG and TIG welding can both be carried out either manually or automatically
- Skill levels for MIG welding are lower than those required for TIG
- Welding speeds for MIG are generally about double those for TIG
- Weld costs per unit length are much higher in TIG welding
- It is generally considered that defect levels in TIG welds are lower than those for MIG.

#### FCAW to MIG

- Both MIG and FCAW can be used manually, automatically and robotically
- MIG wires are available for a wide range of ferrous and non-ferrous materials. FCAW is limited to steel and some types of stainless steels
- Positional welding can be easier using some flux cored wires than with MIG
- MIG requires a shielding gas. Some types of cored wire require a shielding gas but others don't
- MIG is predominantly a workshop process, but gasless cored wires are designed for site work
- Flux cored wires are much less efficient. With MIG, about 98% of the consumable weight is converted into weld metal compared to about 80% for basic and rutile FCAW, and 65% for gasless cored wires
- Welding speeds are very similar between MIG and FCAW
- MIG doesn't create a slag cover, but FCAW requires the slag to be removed
- Weld costs per unit length are generally higher with FCAW than with MIG.

## TIG Comparisons

#### MMA to TIG

- TIG can be used manually or automatically, whereas MMA is predominantly a manual process
- TIG can be used for all metals and alloys, whereas MMA electrodes are available primarily for ferrous materials, stainless steels and nickel alloys
- TIG can be used to weld refractory metals because of its inert gas shield. MMA is not suited to welding these materials
- TIG filler compositions are restricted, but MMA electrodes can be tailored to suit the composition of the parent material
- TIG requires a shielding gas, but MMA does not
- TIG can suffer from drafts disrupting the gas shield. MMA is ideally suited to outside and site work because it doesn't require a shielding gas
- There is very little consumable wastage with TIG welding, almost all of it being converted into weld metal. Consumable wastage levels in MMA are high, with only approximately 65% ending up as weld metal
- TIG doesn't create a slag cover and needs little post weld cleaning, but MMA requires the slag to be removed.

#### MIG to TIG

- TIG and MIG welding can both be carried out either manually or automatically
- Skill levels for TIG welding are much higher than those required for MIG
- Welding speeds for TIG are generally about half those for MIG, with the exception of hot-wire TIG
- Weld costs per unit length are much higher in TIG welding compared with MIG

- Less defects are normally detected in TIG than MIG welds.

### Plasma to TIG

- TIG and plasma welding can both be carried out either manually or automatically
- The arc in plasma welding is hotter than that for TIG

- Plasma can weld greater thicknesses in a single pass than TIG by using the keyhole welding technique
- TIG has a greater tolerance to fit-up of components than plasma.

# Welding Power Sources

## AC Transformers

AC transformers convert the electrical supply voltage and amperage to a safer, usable welding amperage and voltage. These units are suited to applications where external magnetic fields cause magnetic arc blow and the alternating current output eliminates the effect of the magnetic field.

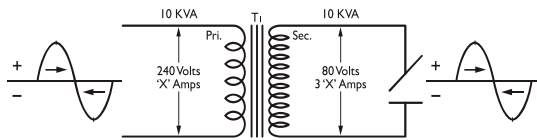

## DC Rectifiers

DC rectifiers offer a more stable welding output, particularly where the highest possible welding standards are required. The direct current output makes these units suitable for a wider range of welding electrodes and applications. DC rectifiers afford easier arc initiation, better out-of-position weld pool control, and they also generate less spatter.

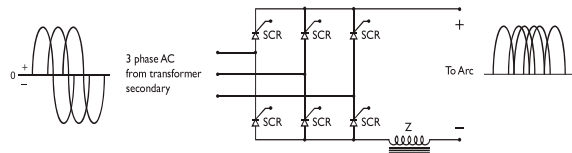

## AC/DC Power Sources

These are power sources that have the option of selecting AC or DC power output. They provide the user with the advantage of using processes requiring either an AC transformer or DC rectifier. Good performance is achievable across the spectrum of welding applications.

## Open Circuit Voltage

The open circuit voltage (OCV) is the voltage measured at the output of a welding transformer when the output is not under load. The open circuit voltage supports arc initiation, and it is important to establish that the welding transformer has sufficient voltage to initiate the arc, particularly when AC transformers are used, less so with DC power sources.

## Restrictions on OCV

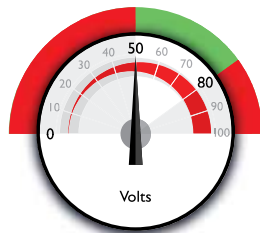

## MMA Process

Poor Welding	Unsafe
Min. OCV is $\pm 50$ V AC	Max OCV is 80 V AC
For good arc striking	For safety reasons
For good arc stability	

## The Need for OCV

Electrode manufacturers specify a minimum OCV requirement for their electrodes.

General Purpose	Low Hydrogen
50 V AC Min	70 V AC Min

## Voltage Reduction Devices

VRD is an abbreviation for voltage reduction devices, or more commonly known as voltage reducers. When a VRD is fitted to a welding machine it reduces the potentially unsafe maximum OCV across the output terminals of the welding machine to a safer voltage. When attempting to strike an arc the VRD will sense this and switch the welding machine to full output whereupon normal welding can commence.

Voltage reducers are devices that are typically connected to constant current welding power sources for use with the MMA process.

It is in most cases not a requirement to fit a VRD for the TIG or MIG processes.

Voltage reducers are typically connected to the secondary (welding output) side of the power source and may be either internally or externally mounted.

## Volt-Ampere Characteristics

### Constant Current

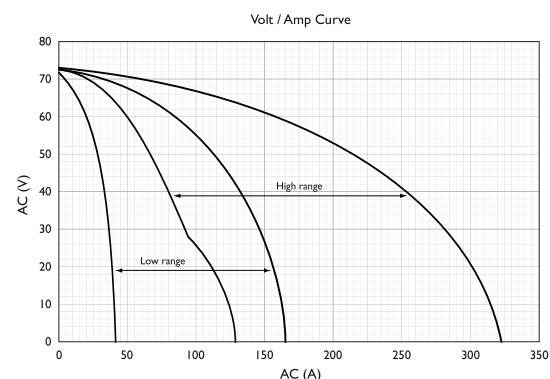

The above volt-ampere (V-A) curve illustrates how welding current changes when arc voltage changes and power source settings remain unchanged. This drooping characteristic is common for MMA and TIG power sources and for processes that utilise voltage-sensing feeders.

A large change in arc voltage will only result in small changes to the current. Arc voltage is affected by arc length, process parameters such as electrode type, shielding gas and arc current. Generally, less skilled welders will prefer the current to stay near constant if the arc length should change with MMA and TIG welding.

### Constant Voltage

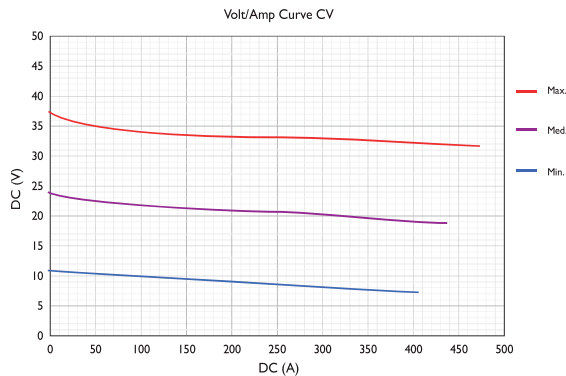

The above graph illustrates the typical volt-ampere relation in constant voltage machines. This V-A characteristic is suitable for maintaining constant arc length in constant-speed processes such as MIG, SAW and flux cored welding. A slight change in arc length (voltage) causes a large change in the welding current. This automatically increases or decreases the electrode melting rate to regain the desired arc length. This effect is called self-regulation.

### Method of Output Control

It is important to select a welding transformer with an output control suited to the application. Stepped output control is less costly, but limits the welder to between fixed amperage or voltage options. Welding applications that require precise output require more accurate control. Moving shunt, moving coil, mag amp and thyristor control provide the welder with the capability to adjust the machine to deliver the precise amperage necessary for high quality welding. The voltage should meet the requirement as stipulated by the electrode manufacturer.

All power sources used for MIG and MAG welding have a DC output, while flux cored wire welding may use either a DC or AC power source, depending on the type of wire in question. Semi-automatic power sources display the following main controls: switches or potentiometers for selection of open circuit/arc voltage, inductance control and burn-off control.

### Voltage Selection

A suitable voltage is selected by a switch or switches on the power source. These switches, in effect, select a number of windings of the primary side of the transformer. Potentiometers set phase angles. The selection of a suitable OCV also determines the amperage that the machine is capable of delivering. This is, however, controlled precisely by the wire feed speed when welding is commenced.

### Inductance

A rise in current to above normal in any electrical circuit results in the melting of the wire at some point. To avoid damage to

the circuit, a fuse is installed at a convenient point. In the event of a current rise as a result of a short-circuit, the fuse wire will melt off and break the circuit. Inspecting a 'blown' fuse can indicate, to a certain extent, what the cause of the overload has been. If the wire in the fuse has only just parted with a small globule of metal on one strand, it indicates a slow, gradual overloading of the circuit. If, however, the wire has 'blown' violently and bits of fuse wire have been flung all over the inside of the capsule, the cause of the overload was certainly a serious short-circuit.

Consider dip transfer (short-circuiting arc) in action. Before the wire strikes the workpiece, there is no flow of current and the voltage has maximum value (i.e. OCV). When the wire strikes the workpiece, one creates what is known as a 'dead short'. This short-circuit causes the current to rise rapidly and burn off the wire violently. This rapid melt flings about metal globules as it takes place.

These globules settle on the workpiece and welding torch in the form of 'spatter'. To control the rate of rise of short-circuiting current, a choke (or inductor) is fitted in series with the welding power cable. This inductor thus 'chokes' the rate of rise of current and ensures a smooth arc condition.

Inductance controls the rate of rise of short-circuiting current. It becomes evident that inductance must be a function of time and current, since it controls the time taken for the current to rise to the pre-set value. Hence an increase in inductance results in less frequent short-circuiting. Fewer short-circuits imply that the arc is present for a longer duration of time. Increased 'arc-on' time means increased heat input.

On heavier plate, where more heat is required to ensure good fusion, more inductance would contribute immensely. Conversely, on thinner sections, less inductance would lead to a decrease in 'arc-on' time, and consequently a 'cooler' arc that enables thin materials to be welded with ease.

### Duty Cycle

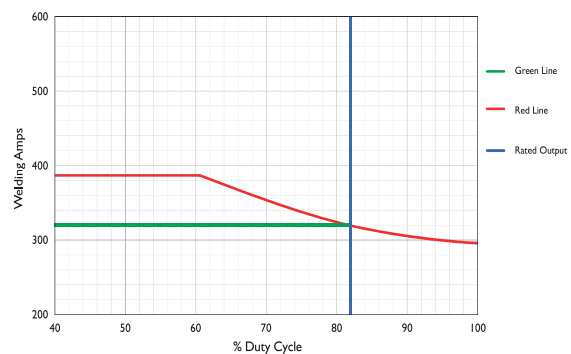

Duty cycle is defined as the ratio of arc on time to total time. For a welding machine it is normal to consider a 10 minute time period. In the above example, the duty cycle of the machine is 82% at 320 A. The duty cycle for other amperages can be calculated by using the following equation:

$$\% \text{ Duty Cycle} = \frac{(\text{Rated Current})^2}{(\text{Load Current})^2} \times (\text{Rated Duty Cycle})$$

Furthermore by using the following equation it is possible to determine the amperages at any given duty cycle:

$$\text{Amps (Req)} = \sqrt{\frac{\text{Amps}^2 (\text{Given}) \times \text{Duty Cycle (Given)}}{\text{Duty Cycle (Req)}}}$$

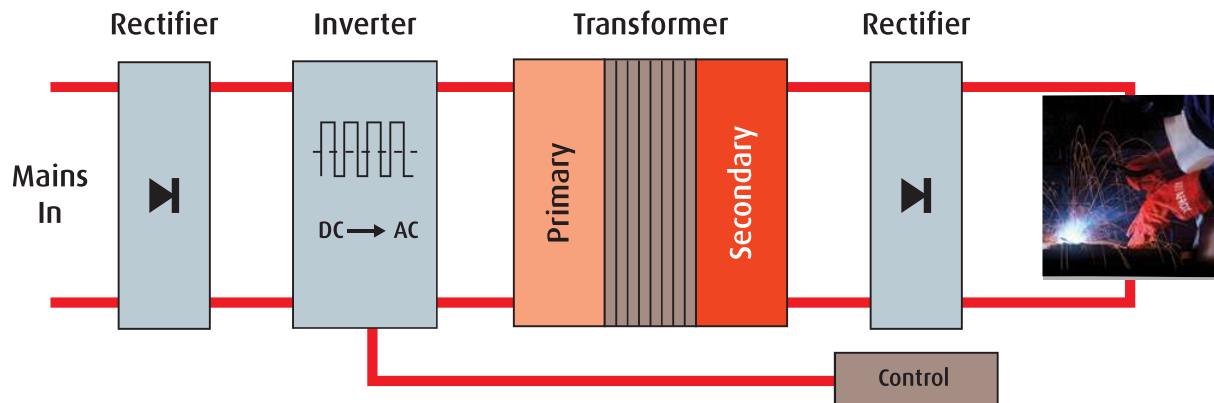

### Inverter Technology

The primary rectifier-inverter circuits (often referred to as 'inverters' in welding power source literature) allow the advantages of electronic control to be obtained more economically. This type of circuit is common in low power domestic applications such as television and computer power supplies.

It is a type of power source that became viable when relatively high power switching devices became available. The AC mains input is first rectified, then the high voltage DC output of the rectifier is fed to an inverter which converts the DC to high frequency alternating current by a variety of semiconductor switching circuits. The high voltage-high frequency AC is reduced to a safe level suitable for welding by a transformer and finally rectified to produce a DC output. Control is achieved by pulse width modulation or mark-space control of the switching devices.

This apparently complex circuit is justified by the effect of the increased AC frequency on the transformer. The size, weight and cost of a transformer depends on its frequency, as the operating frequency increases, the size is reduced. AC frequencies of 100 kHz are achievable with commercially available semi-conductors. A transformer operating at this frequency is dramatically smaller than the normal 50 Hz mains transformer. In addition, regardless of whether a single or three-phase mains input is used, the 'inverter' transformer is a single-phase device.

### Conventional and Inverter Transformers

The influence on transformer size, shown above, is where a conventional three-phase 200 A transformer is compared with a 20 kHz, 200 A transformer. The reduction in copper windings and iron laminations, in addition to the reduced labour content involved in its construction, significantly reduce the transformer cost. The electrical efficiency is also reduced due to the absence of a magnetising current drain in the transformer.

The effect on the final power source size is quite dramatic. A typical 150 A inverter power source will only weigh 5-8 kg, compared to between 20 and 50 kg for a conventional transformer power source.

### Typical Dimensions of Inverter versus Conventional Power Sources

Dimensions	Conventional Power Source (mm)	Inverter Power Source (mm)
Height	290	250
Width	215	123
Length	370	305

As the cost of the electronic power devices has reduced and reliability of the designs has improved, the primary rectifier-inverter has become competitive for a wide range of welding power source applications.

The power switching devices used in the inverter stage vary depending on the design and the manufacturer. They must be specifically rated for the high switching frequencies and voltages present, but devices such as asymmetrical SCRs (ASCRs), Field-Effect Transistors (FETs) and Metal-Oxide Semiconductor Field-Effect Transistors (MOSFETs) are among the components successfully used.

# Welding Power Source Comparisons

A summary of power source types and their capabilities is given below:

Power Source Type	Output Characteristics	Electrical Efficiency	Physical Characteristics	Relative Cost	Applications
Motor generator – (mains powered electric motor driven)	Variable – slow response rate	Poor	Large and noisy, subject to mechanical wear	Expensive	MMA, SAW
Engine driven generator – (petrol, diesel, gas engine driven)	Variable – relatively slow response rate	N/A	Wide range – small petrol to large diesel	High	Field welding, MMA, MIG where no mains power available
Conventional tapped transformer-rectifier, moving iron, variable inductor, magnetic amplifier, etc.	Fixed at design stage, slow response rate, no mains voltage stabilisation	Fair – but magnetising current and thermal losses in transformer	Relatively heavy and industrial duty units are large but robust and reliable	Cheap	MIG, MMA and TIG. Hobby units and general purpose fabrication
SCR phase control	Electronically variable within response limits of switching system. Mains stabilised but high ripple especially at low output	Fair	May be more compact than conventional design due to reduction in size of magnetic (wound) components	High	Manual and mechanised MIG/TIG and manual MMA. Medium to high quality fabrications
Transistor series regulator	Very fast response, flexible control, waveform control, accurate, ripple free, repeatable	Poor	Fairly large, may be water-cooled	Very expensive	High quality mechanised and automated MIG and TIG. Precision engineering and R&D
Hybrid and secondary chopper	Fast response, variable output, stable and repeatable	Good	Medium size, air-cooled	High	Medium to high quality manual and automated, multiprocess
Primary rectifier-inverter	Fast response, variable output, stable and repeatable	Very good	Compact – electronically complex	Medium	Medium to high quality manual and automated, multiprocess

The most common industrial units remain the tapped transformer-rectifier and primary inverter rectifier types. Selection is usually based on cost and fitness for purpose.

## Health and Safety

Welding power sources are electrical devices which often operate at high voltages. Electric shock is a common hazard in welding and cutting operations.

There are several essential rules related to the safe installation and operation of this type of equipment which must be observed if electric shock injury is to be avoided:

- Equipment should always be installed by competent, qualified personnel
- Equipment must not be operated with protective casework removed
- Equipment should be regularly maintained and tested (eg. for insulation resistance)

- Equipment should comply with national standards
- The class of protection (IP number) should meet working environment requirements.

Due to the potential severity of the hazard, the following is a guide on what to do before any MIG welding is started to reduce the risk of an electrical accident:

- Only qualified personnel should be allowed to install MIG equipment
- Whoever does install the equipment must ensure that it complies with national standards, any local regulations, the manufacturer's instructions and workpiece 'earthing' requirements
- All equipment should be tested to ensure it is operating correctly and safely before being put into service.



# ARC EQUIPMENT

## Afrox Industrial Range

### Highlights

**Delivers superior performance** - These single- and three-phase machines are ideal for welding carbon steel, stainless steel and aluminium. They offer high arc stability and clean weld finish.

**Simplistic front panel design** - User-friendly layout makes setting voltage, wire speed and inductance easy. For segregated (remote) wire feeder-machine combinations, adjusting welding parameters can be done from the wire feeder.

**Polarity change for cored wires**

**Protection from grime** - improved tunnel design keeps dust and grime away from electronic parts and maximises cooling.

**Gas purge** - ensures weld defects are minimised by clearing the line after changing cylinders or when the machine has not been used for a period of time.

### Advantages

**Infinite voltage, wire speed and inductance settings** - The infinite control over voltage wire speed and inductance ensures you can fine tune settings for optimum results.

**Easy-grip handles** - Ergonomically designed soft feel handles make moving the power source and wire feeders easy.

**Low slung cylinder tray** - The design includes a lowered cylinder tray to ensure heavy cylinders can be placed onto the machine safely and with ease.

### Abbreviations

CC	= Constant Current
CV	= Constant Voltage
MIG	= Metal Inert Gas Welding
TIG	= Tungsten Inert Gas Welding
FCAW	= Flux Cored Arc Welding
MCAW	= Metal Cored Arc Welding

### Applications

CC	= MMA & TIG
CV	= MIG, FCAW & MCAW

# MIG Power Sources



## Afrox Industrial MIG 251C

Item Number	W500251
-------------	---------

The Afrox Industrial MIG 251C is a 230 V single-phase DC compact machine for the medium and light industrial sectors. It features inductance control, close loop current control, arc spot timer and burn back control. Power source is capable of producing welds with the MMA, Lift-TIG and MIG processes. The Afrox Industrial MIG 251C comes standard with digital volt and amp meter display, built-in VRD, 2-roll wire feeding system, 18 kg spool capacity and undergear with integrated cylinder rack.

Package includes:

- \* Afrox Industrial MIG 251C DC compact power source
- \* 4 m earth cable and clamp

Optional extras:

- |         |  |
|---------|--|
| W500063 | Transarc® OHE410 Auto Darkening Helmet |
| W500252 | MIG Kit: MIG 251C                      |
| W500255 | MMA Kit: Afrox Industrial Compact MIG  |
| W500256 | TIG Kit: Afrox Industrial Compact MIG  |

Afrox Industrial MIG 251C DC Compact power source is backed by a two-year warranty and is subject to the terms and conditions stipulated in the owner's manual.

### W500252 MIG Kit

MIG 251C includes:

- 1 x W032003 MIG Gun – BZL – MB 25 AK A/C MIG Gun 4 m
- 2 x W053033 Skull Cap with Back Flap
- 1 x W033980 MIG Accessories – Noryl Basket Adaptor
- 1 x W003037 Shieldmaster® Flowmeter 30 LPM CO<sub>2</sub>/AR
- 1 x W051023 Classic Blue and Yellow Welding Gauntlet
- 1 x 6 m Inert Gas Hose 5 mm with Fittings for Shieldmaster® Flowmeter + 1 x 5 mm O-Clip Loose

### W500255 MMA Kit

Afrox Industrial Compact MIG includes:

- 1 x Suhan Jaw Type Electrode Holder 300 A + 4 m Grey PVC Welding Cable 300 A 35 mm<sup>2</sup> with Male Dinse Plug (50 – 70)
- 1 x W051021 Classic Red Welding Gauntlet

### W500256 TIG Kit

Afrox Industrial Compact MIG includes:

- 1 x TWP 26 V 3,8 m 200 A A/C TIG Torch with Male Dinse Plug (50 – 70)
- 1 x W031012 Witstar TIG Tungsten Pack 2,4 mm
- 1 x W031160 TIG Spares – Nozzle 10 mm #6
- 1 x W031152 TIG Spares – Collet 2,4 mm
- 1 x W031156 TIG Spares – Collet Body 2,4 mm
- 1 x W051024 TIG Welders' Glove



### Arox Industrial MIG 313C

Item Number W500313

The Arox Industrial MIG 313C is a 380 V three-phase DC compact machine for the medium and light industrial sectors. It features inductance control, close loop current control, arc spot timer and burn back control. Power source is capable of producing welds with the MMA, Lift-TIG and MIG processes. The Arox Industrial MIG 313C comes standard with digital volt and amp meter display, built-in VRD, 2-roll wire feeding system, 18 kg spool capacity and undergear with integrated cylinder rack.

#### Package includes:

- \* Arox Industrial MIG 313C DC Compact power source
- \* 4 m earth cable and clamp

#### Optional extras:

- |         |  |
|---------|--|
| W500063 | Transarc® OHE410 Auto Darkening Helmet |
| W500253 | MIG Kit: MIG 313C                      |
| W500255 | MMA Kit: Arox Industrial Compact MIG   |
| W500256 | TIG Kit: Arox Industrial Compact MIG   |

Arox Industrial MIG 313C DC Compact power source is backed by a two-year warranty and is subject to the terms and conditions stipulated in the owner's manual.

#### W500253 MIG Kit

##### MIG 313C includes:

- 1 x W032004 MIG Gun – BZL – MB 36 KD A/C MIG Gun 4 m
- 2 x W050533 Skull Cap with Back Flap
- 1 x W033980 MIG Accessories – Noryl Basket Adaptor
- 1 x W003037 Shieldmaster® Flowmeter 30 LPM CO<sub>2</sub> /AR
- 1 x W051023 Classic Blue and Yellow Welding Gauntlet
- 1 x 6 m Inert Gas Hose 5 mm with Fittings for Shieldmaster® Flowmeter + 1 x 5 mm O-Clip Loose

#### W500255 MMA Kit

##### Arox Industrial Compact MIG includes:

- 1 x Suhan Jaw Type Electrode Holder 300 A + 4 m Grey PVC Welding Cable 300 A 35 mm<sup>2</sup> with Male Dinse Plug (50 – 70)
- 1 x W051021 Classic Red Welding Gauntlet

#### W500256 TIG Kit

##### Arox Industrial Compact MIG includes:

- 1 x TWP 26 V 3,8 m 200 A A/C TIG Torch with Male Dinse Plug (50 – 70)
- 1 x W031012 Witstar TIG Tungsten Pack 2,4 mm
- 1 x W031160 TIG Spares – Nozzle 10 mm #6
- 1 x W031152 TIG Spares – Collet 2,4 mm
- 1 x W031156 TIG Spares – Collet Body 2,4 mm
- 1 x W051024 TIG Welders' Glove



### Arox Industrial MIG 403C

Item Number W500403

The Arox Industrial MIG 403C is a 380 V three-phase DC compact machine for the medium industrial sectors. It features inductance control, close loop current control, arc spot timer and burn back control. Power source is capable of producing welds with the MMA, Lift-TIG and MIG processes. The Arox Industrial MIG 403C comes standard with digital volt and amp meter display, built-in VRD, 4-roll wire feeding system, 18 kg spool capacity and undergear with integrated cylinder rack.

#### Package includes:

- \* Arox Industrial MIG 403C DC Compact power source
- \* 4 m earth cable and clamp

#### Optional extras:

- |         |  |
|---------|--|
| W500063 | Transarc® OHE410 Auto Darkening Helmet |
| W500254 | MIG Kit: MIG 403C                      |
| W500255 | MMA Kit: Arox Industrial Compact MIG   |
| W500256 | TIG Kit: Arox Industrial Compact MIG   |

Arox Industrial MIG 403C DC Compact power source is backed by a two-year warranty and is subject to the terms and conditions stipulated in the owner's manual.

#### W500254 MIG Kit

##### MIG 403C includes:

- 1 x W032007 MIG Gun – BZL – MB 40 KD A/C MIG Gun 4 m
- 2 x W050533 Skull Cap with Back Flap
- 1 x W033980 MIG Accessories – Noryl Basket Adaptor
- 1 x W003037 Shieldmaster® Flowmeter 30 LPM CO<sub>2</sub> /AR
- 1 x W051023 Classic Blue and Yellow Welding Gauntlet
- 1 x 6 m Inert Gas Hose 5 mm with Fittings for Shieldmaster® Flowmeter + 1 x 5 mm O-Clip Loose

#### W500255 MMA Kit

##### Arox Industrial Compact MIG includes:

- 1 x Suhan Jaw Type Electrode Holder 300 A + 4 m Grey PVC Welding Cable 300 A 35 mm<sup>2</sup> with Male Dinse Plug (50 – 70)
- 1 x W051021 Classic Red Welding Gauntlet

#### W500256 TIG Kit

##### Arox Industrial Compact MIG includes:

- 1 x TWP 26 V 3,8 m 200 A A/C TIG Torch with Male Dinse Plug (50 – 70)
- 1 x W031012 Witstar TIG Tungsten Pack 2,4 mm
- 1 x W031160 TIG Spares – Nozzle 10 mm #6
- 1 x W031152 TIG Spares – Collet 2,4 mm
- 1 x W031156 TIG Spares – Collet Body 2,4 mm
- 1 x W051024 TIG Welders' Glove

# TIG Power Sources



## Afrox Industrial TIG 185 AC/DC CC Package

Item Number W035186

### Please note:

- Shielding gas and welding consumable requirements are excluded from above packages and should be selected according to customer requirements.
- Please refer to the Shielding Gases and Welding Consumables section for detailed product specification and description.

Single-phase 230 VAC +-15%, 50/60 Hz. Rated at 185 A, 35% duty cycle.

A lightweight AC/DC inverter power source that provides a consistent welding arc for the TIG and MMA processes. Power source comes standard with frequency, post flow and down slope control.

Applications include; DIY and light maintenance for welding of aluminium, carbon steel and stainless steel applications.

Package includes:

- Afrox Industrial TIG 185 AC/DC CC power source
- Air-cooled CK HF-TIG torch kit
- Electrode holder and welding cable
- Earth clamp and welding cable
- S6000 Regulator 40 $\ell$  CO $_2$ /Argon
- 3 m inert gas hose and fittings



## Afrox Industrial TIG 201P 230 V

Item Number W500201

### Please note:

- Shielding gas and welding consumable requirements are excluded from above packages and should be selected according to customer requirements.
- Please refer to the Shielding Gases and Welding Consumables section for detailed product specification and description.

Single-phase 230 VAC +-15%, 50/60 Hz. Rated at 200 A, 60% duty cycle.

A lightweight DC inverter power source that provides a consistent welding arc for the TIG and MMA processes. Power source comes standard with high frequency, pulsating feature, post flow and down slope control. Remote capabilities

Applications include; DIY and light maintenance for welding of carbon steel and stainless steel applications.

Power source includes:

- 2 x male dinse plugs

Optional extras:

- W031186 TWP 26 HF TIG Kit
- W030911 RFCS-14HD foot Control
- W030912 RHC-14 Hand Control
- W030913 RCC-14 Finger Tip Control



### Afrox Industrial TIG 303PU 380 V

Item Number

W500303

Three-phase 380 VAC  $\pm$ 15%, 50/60 Hz. Rated at 300 A, 60% duty cycle.

Inverter based TIG/MMA power source which incorporates high frequency ignition, line voltage protection and a built-in voltage reduction device. Includes USB data logging of welding parameters. DC TIG/MMA. Remote capability.

Applications include; DIY and light maintenance for welding of carbon steel and stainless steel applications.

Power source includes:

- 2 x male dinse plugs

Optional extras:

W031186 TWP 26 HF TIG Kit

W030911 RFCS-14HD Foot Control

W030912 RHC-14 Hand Control

W030913 RCC-14 Finger Tip Control

# MMA Power Sources



## Afrox Industrial 220i 220 V DC Inverter

Item Number	W046223
-------------	---------

The Afrox Industrial 220i is a 230 V single-phase DC MMA/Lift DC TIG machine. Rated at 220 A, 80% duty cycle.

A lightweight, durable industrial inverter power source, backed by a two-year warranty, subject to terms and conditions stipulated in the owner's manual. Afrox Industrial 220i power source comes standard with digital amp meter and built-in voltage reduction device.

Applications including medium and light industrial sectors. It is particularly suitable for the mining industry.

Power source includes:  
 • 2 x male dinse plugs

Optional extras:

- W500063 Transarc® OHE410 Auto Darkening Helmet
- W051021 Classic Red Welding Gauntlet
- W051024 TIG Welders' Glove
- W053102 Welding Cable PVC 300 A 35 mm<sup>2</sup> Grey/metre
- W054146 Earth Clamp 300 A Crocodile
- W053011 Cable Lugs Crimping 35 x 12 mm
- W053090 Suhan Jaw Type 300 A Electrode Holder
- W053095 Optimus Type 300 A Electrode Holder
- W031263 TIG Torches – TWP 26 V 3,8 m 200 A A/C  
(Consumables sold separately)
- W003037 Shieldmaster® Flowmeter 30 LPM CO<sub>2</sub>/AR



## Afrox Industrial MMA 221S

Item Number	W500221
-------------	---------

The Afrox Industrial MMA 221S is a 230 V single-phase DC MMA machine for the medium and light industrial sectors. Rated at 220 A, 60% duty cycle. It features DIG (arc force), anti-stick and adjustable hot start functions. Power source is capable of producing welds with the MMA and Lift-TIG processes. The Afrox Industrial MMA 221S comes standard with digital amp meter display and built-in voltage reduction device.

Power source includes:  
 \* 2 x male dinse plugs

Afrox Industrial 221S DC CC Inverter power source is backed by a two-year warranty and is subject to the terms and conditions stipulated in the owner's manual.

Optional extras:

- W500063 Transarc® OHE410 Auto Darkening Helmet
- W051021 Classic Red Welding Gauntlet
- W051024 TIG Welders' Glove
- W053102 Welding Cable PVC 300 A 35 mm<sup>2</sup> Grey/metre
- W054146 Earth Clamp 300 A Crocodile
- W053011 Cable Lugs Crimping 35 x 12 mm
- W053090 Suhan Jaw Type 300 A Electrode Holder
- W053095 Optimus Type 300 A Electrode Holder
- W031263 TIG Torches – TWP 26 V 3,8 m 200 A A/C  
(Consumables sold separately)
- W003037 Shieldmaster® Flowmeter 30 LPM CO<sub>2</sub>/AR



## Arox Industrial MMA 323S

Item Number	W500323
-------------	---------

The Arox Industrial MMA 323S is a 380 V/525 V three-phase DC MMA machine for the medium and light industrial sectors. It is particularly suitable for the mining industry. It features DIG (arc force), anti-stick and adjustable hot start functions. Power source is capable of producing welds with the MMA and Lift-TIG processes. The Arox Industrial MMA 323S comes standard with digital amp meter display, built-in VRD, close loop current control for accurate current setting and line voltage protection to compensate for electrical spikes from input supply. Rated at 320 A, 60% duty cycle.

Power source includes:  
\* 2 x male dinse plugs

Arox Industrial 323S DC CC Inverter power source is backed by a two-year warranty and is subject to the terms and conditions stipulated in the owner's manual.

Optional extras:

- W500063 Transarc® OHE410 Auto Darkening Helmet
- W051021 Classic Red Welding Gauntlet
- W051024 TIG Welders' Glove
- W053102 Welding Cable PVC 300 A 35 mm<sup>2</sup> Grey/metre
- W053103 Welding Cable PVC 400 A 50 mm<sup>2</sup> Grey/metre
- W054148 Earth Clamp 600 A Crocodile
- W053012 Cable Lugs Crimping 50 x 12 mm
- W053096 Electrode Holder – TRC – 400 A Optimus Type
- W054201 Electrode Holder – AOX – 400 A Jaw Type
- W054202 Electrode Holder – AOX – 400 A Twist Lock
- W031263 TIG Torches – TWP 26 V 3,8 m 200 A A/C  
(Consumables sold separately)
- W003037 Shieldmaster® Flowmeter 30 LPM CO<sub>2</sub>/AR

Three-phase 380 V/525 VAC +- 15%, 50/60 Hz. Rated at 320 A, 80% duty cycle.

The Arox Industrial 320i 380 V/525 V inverter power source with its dual power option is suitable for various work environments. Applications include; medium to heavy maintenance, fabrication and manufacturing of mining and construction equipment where three-phase 380 V - 525 V is a requirement.

Power source includes:  
\* 2 x male dinse plugs

Optional extras:

- W500063 Transarc® OHE410 Auto Darkening Helmet
- W051021 Classic Red Welding Gauntlet
- W051024 TIG Welders' Glove
- W053102 Welding Cable PVC 300 A 35 mm<sup>2</sup> Grey/metre
- W053103 Welding Cable PVC 400 A 50 mm<sup>2</sup> Grey/metre
- W054148 Earth Clamp 600 A Crocodile
- W053012 Cable Lugs Crimping 50 x 12 mm
- W053096 Electrode Holder – TRC – 400 A Optimus Type
- W054201 Electrode Holder – AOX – 400 A Jaw Type
- W054202 Electrode Holder – AOX – 400 A Twist Lock
- W031263 TIG Torches – TWP 26 V 3,8 m 200 A A/C  
(Consumables sold separately)
- W003037 Shieldmaster® Flowmeter 30 LPM CO<sub>2</sub>/AR



## Arox Industrial 320i 380 V/525 V DC Inverter

Item Number	W046321
-------------	---------

# Multiprocess Power Sources



## Afrox Industrial 453M

Item Number

W500453

Three-phase 380/525 VAC +-15%, 50/60 Hz. Rated at 450 A, 60% duty cycle.

The Afrox Industrial 453M 380 V/525 V Multiprocess inverter power source is capable of delivering high integrity welds and its dual input power option can accommodate various input power requirements.

Applications include: Medium to heavy maintenance, engineering, fabrication and manufacturing of mining and construction equipment.

Power source includes:

- Built-in voltage reducer for MMA/TIG
- 2 x male dinse plugs

Optional extras:

W500400 Afrox Industrial 4-Roll Wire Feeder Base

W500401 Afrox Industrial 4-Roll Wire Feeder Deluxe

Undercarriage, wire feeder and cylinder rack available on request from Afrox Service Engineering Department.



## Afrox Industrial 4-Roll Wire Feeder Base

Item Number

W500400

Wire feeder includes:

- 1,0 mm/1,2 mm V-groove drive rolls
- 5 m air-cooled interkon kit for Afrox Industrial 453M Power Source



## Afrox Industrial 4-Roll Wire Feeder Deluxe

Item Number

W500401

- The Afrox Industrial 4-Roll Wire Feeder Deluxe is compatible only with the Afrox Industrial 453M power source
- V-knurled and U-groove drive rolls available on request from Afrox Service Engineering Department

Wire feeder includes:

- 1,0 mm/1,2 mm V-groove drive rolls
- 5 m air-cooled interkon kit for Afrox Industrial 453M Power Source



# Afrox Transarc® Range



## Transarc® 180P PortaMIG DC CV Package

Item Number

W034181

Single-phase 230 VAC  $\pm$ 15%, 50/60 Hz. Rated at 180 A, 35% duty cycle.

The Transarc® 180P offers a compact (built-in wire feeder) inverter technology power source with infinitely variable voltage, amperage and inductance control for easy setting of welding parameters.

Applications include; DIY, light maintenance and engineering.

Package includes:

- Afrox Transarc® 180P PortaMIG DC CV power source
- PortaMIG trolley
- Portashield gas cylinder
- Drive roll kit:
  - \*Double-sided V-Groove 0,6 mm & 0,8 mm, 0,8 mm & 1,0 mm, 1,0 mm & 1,2 mm
  - \*Single-sided V-Knurled 0,9 mm
- \*\*Binzel MB 15 AK MIG gun
- S6000 Regulator 40ℓ CO<sub>2</sub>/Argon
- Noryl basket adaptor
- 3 m inert gas hose and fittings

\* Drive roll kit comprises one drive roll per pack

\*\*Binzel MIG gun includes liner, tip adaptor/gas diffuser, contact tip and gas shroud.

### Please note:

- Welding consumable requirements are excluded from above package and should be selected according to customer requirements.
  - Please refer to the Welding Consumables section for detailed product specification and description.

# Plasma Power Sources



## Transarc® Plasma Cut 40 Power Source

Item Number

W036440

Single-phase 230 VAC +-15%, 50/60 Hz. Rated at 40 A, 35% duty cycle.

The Transarc® Plasma Cut 40 offers a lightweight (weighs only 8 kg) inverter technology plasma power source for the cutting of various metals. Plasma Cut 40 requires air at 4 bar input pressure and features a post flow selector switch and air control connector.

Applications include; art sculptures, hobby and DIY enthusiasts  
Cutting thickness; carbon steel 9 mm, stainless steel 8 mm, aluminium 4 mm

Package includes:

- Afrox Transarc® Plasma Cut 40 power source
- \*PT-31 plasma torch
- Air control connector
- Earth clamp and cable

\*Plasma torch supplied with first set of consumables

Please note:

- Gas requirements are excluded from above package and should be selected according to customer requirements.
  - Please refer to the Compressed Gases section for detailed product specification and description.

\*Plasma torch supplied with first set of consumables

W036441 Transarc® Plasma 40 Torch

W036443 Transarc® Plasma 40 Electrode PT-31

W036444 Transarc® Plasma 40 Cutting Tip PT-31

W036445 Transarc® Plasma 40 Shield Cup PT-31

W036446 Transarc® Plasma 40 Switch PT-31

W036447 Transarc® Plasma 40 Diverter PT-31

# Miller Range

## MIG Packages



### Miller MigMatic® 320i

Item Number

W034338

Miller MigMatic® 320i, 320 A, 30 V at 35% duty cycle, 400 V, three phases (50/60 Hz) power source only.

Miller MigMatic® 320i synergic MIG/MAG system featuring a heavy duty drive mechanism capable of consistent and precise wire feeding regardless of your choice of wire. The machines are quick to set up and the graphical user interface makes it easy to achieve those perfect weld parameters with very limited training required. The MigMatic® 320i is the perfect workshop tool and ideal for both solid and flux core wires.

Accessories not included.



### Miller MigMatic® 400ip

Item Number

W034337

Miller MigMatic® 400ip, 400 A, 34 V at 80% duty cycle, 400 V, three phases (50/60 Hz) package.

Miller MigMatic® S400iP synergic pulsed MIG/MAG system offers full flexibility. All modules are bespoke to the system and designed for trouble-free, high productivity welding. Never before has it been so easy and straightforward to achieve excellent welding performance. Enjoy full control at all times.

Package includes power source, interconnecting cable air, feeder and undergear. (Water cooler sold separately).

Accessories sold separately.



## Miller XPS 450 Deluxe Package

Item Number

W034450

Three-phase 380 VAC  $\pm$ 15%, 50 Hz. Rated at 450 A, 45% duty cycle, 320 A 100% duty cycle.

The Miller XPS 450 with a segregated (remote) wire feeder provides greater flexibility for the operator. This industrial heavy duty package comes standard with a rugged deluxe four-drive-roll wire feeder that features an adjustable run-in control that allows for optimal arc starting. The Miller XPS 450 comes standard with 40 voltage step selection for exceptional arc stability. Additional features include trigger latch option, gas purging and burn back control and multiple inductance selection ports.

Applications include; medium to heavy engineering, fabrication and manufacturing of mining and construction equipment, with the use of the MIG, FCAW and MCAW process.

Package includes:

- Miller XPS 450 DC CV power source
  - Power source supplied with undergear cylinder and vertical cooler rack
- Drive roll kit:
  - \*Double-sided V-Groove 1,0 mm & 1,2 mm
- \*\*Binzel MB 40 KD MIG gun (W032007)
- Earth clamp and welding cable
- Shieldmaster® flowmeter regulator CO<sub>2</sub>/Argon (W003037)
- Noryl basket adaptor (W033980)
- 3 m inert gas hose and fittings

\* Drive roll kit comprises 4 drive rolls, inlet and intermediate guides

\*\*Binzel MIG gun includes liner, tip adaptor/gas diffuser, contact tip and gas shroud.

### Please note:

- Shielding gas and welding consumable requirements are excluded from above packages and should be selected according to customer requirements.
  - Please refer to the Shielding Gases and Welding Consumables section for detailed product specification and description.

# TIG Power Sources



Miller Maxstar 161 STH Package

Item Number

W052151

Single-phase 50/60 Hz. Rated at 160 A 20% duty cycle, 110 A 100% duty cycle. High frequency TIG (GTAW), pulsed TIG (GTAW-P), MMA.

Ideal for light industrial applications. Built-in voltage reduction device.

Package includes:

- Maxstar 161 power source
- 2 m power cable (no plug)
- X-CASE provides protection in transport and storage
- RCCS-6M remote finger tip control (W195184)
- Weldcraft A-150 (WP-17) 3,8 m TIG torch with connector
- Stick electrode holder with 4 m cable
- Earth clamp with 3 m cable
- Shieldmaster® flowmeter with gas hose
- AK2C accessory kit
- Handle/shoulder strap



Miller Maxstar 280 DX 208 V-575 V CPS

Item Number

W030151

Auto-line 208 V - 575 V 50/60 Hz. Rated at 235 A, 60% duty cycle. High frequency DC TIG, pulsed TIG, stick (SMAW) and air carbon capability.

Applications include; fabrication, petrochemical aerospace, food/beverage industry and shipyards.

Power source includes:

- 2,5 m power cable
- Cooler power supply
- 2 x male dinse plugs

Optional extras:

- W031186 TWP 26 HF TIG Kit
- W030911 RFCS-14 HD Foot Control
- W030912 RHC-14 Hand Control
- W030913 RCC-14 Finger Tip Control
- Weldcraft TIG Torches
- Wireless Remote Controls



### Miller Dynasty® 210 DX 120 V - 480 V CPS

Item Number

W030200

Auto-line 120 V-480 V 50/60 Hz. Rated at 210 A. 60% duty cycle.

The Miller Dynasty® 210 DX with its AC balance and frequency control makes welding of aluminium an easy task.

Applications include; DIY, precision, heavy fabrication, pipe and tube fabrication and aerospace.

Process capabilities:

- AC/DC TIG (GTAW)
- Pulsed TIG (GTAW-P)
- Stick (SMAW)

Power source includes:

- 2 x male dinse plugs

Optional extras:

- W031186 TWP26 HF TIG Kit
- W030911 RFCS-14 HD Foot Control
- W030912 RHC-14 Hand Control
- W030913 RCC-14 Finger Tip Control

Available from Afrox Service Engineering Department:

- Weldcraft TIG torches
- Wireless remote controls
- Coolmate 1,3 Cooler



### Dynasty® 400 TiGRunner

Item Number

W700001

Dynasty® 400 TiGRunner; 300 A at 32 V, 60% duty cycle, 3-400 A, 208-575 V, 3- or single-phase power auto line technology.

The Dynasty® AC/DC TIG machine has been designed for ease of use without compromising on the weld performance. Allows for any input voltage hook up (208-575 V) with no manual linking, providing convenience in any job setting. Ideal solution for dirty or unreliable power.

Blue Lightning™ high-frequency (HF) arc starter for non-contact arc initiation provides more consistent arc starts and greater reliability compared to traditional HF arc starters.

Programme memory features nine independent programme memories that maintain/save your parameters.

#### AC Waveforms

Advanced squarewave, fast freezing puddle, deep penetration and fast travel speeds.

Soft squarewave for a soft, buttery arc with maximum puddle control and good wetting action.

Sine wave for customers that like a traditional arc. Quiet with good wetting.

Triangular wave reduces the heat input and is good on thin aluminum. Fast travel speeds.

Including power source, water cooler and running gear. Accessories sold separately.



### Syncrowave® 300 TIGRunner

Item Number

W700002

Syncrowave® 300 TIGRunner; 300 A at 22 V, 30% duty cycle, 5-300 A, max OCV 60 VDC.

The Syncrowave® AC/DC TIG machine has been designed for ease of use without compromising on the weld performance. The machine can be set for AC TIG, DC TIG or MMA in no time. The simple and clean control panel reduces the set up time and improves productivity.

400 V, 50/60 Hz, incl. power source, water cooler and running gear. Accessories sold separately.



### Syncrowave® 400 TIGRunner

Item Number

W700003

Syncrowave® 400 TIGRunner; 400 A at 26 V, 30% duty cycle, 5-400 A, max OCV 70 VDC.

The Syncrowave® AC/DC TIG machine has been designed for ease of use without compromising on the weld performance. The machine can be set for AC TIG, DC TIG or MMA in no time. The simple and clean control panel reduces the set up time and improves productivity.

400 V, 50/60 Hz, incl. power source, water cooler and running gear. Accessories sold separately.

# MMA Power Sources

## Miller Blue-Thunder Series

The Miller Blue-Thunder MMA (stick) welding power sources with electromagnetic shunt control combine good welding performance with practicality.

The Afrox range comprises two models; Blue-Thunder 443 and Blue-Thunder 343.

Applications include; mining fabrication, structural fabrication, trailer fabrication, maintenance and repair.



Three-phase 380/525 VAC  $\pm$ 15%, 50/60 Hz. Rated at 420 A, 45% duty cycle.

Package includes:

- Miller Blue-Thunder 443 DC CC power source
- Power source supplied with running gear

### Miller Blue-Thunder 443 DC CC Power Source

Item Number

W052420

Optional equipment:

- Earth clamp and welding cable
- Electrode holder and welding cable
- External voltage reducer



Three-phase 380 VAC  $\pm$ 10%, 50/60 Hz. Rated at 200 A, 40% duty cycle.

Miller STi 203 DC inverter-based power source provides superb welding performance with the MMA and Lift-arc TIG processes.

This power source features a remote control port for remote amperage control, arc force (dig) control and adaptive hot start for difficult-to-weld electrodes.

Applications include; petrochemical, process piping, maintenance and light fabrication.

Package includes:

- Miller STi 203 DC CC power source

### Miller STi 203 DC CC Power Source

Item Number

W034094

Optional equipment:

- Earth clamp and welding cable
- Electrode holder and welding cable

#### Please note:

- Arc accessories and welding consumable requirements are excluded from above packages and should be selected according to customer requirements.

- Please refer to the Arc Accessories and Welding Consumables section for detailed product specification and description.





### Miller STR 500 DC CC Power Source

Item Number

W034085

Available on request

Three-phase 380 VAC +-10%, 50/60 Hz. Rated at 500 A, 35% duty cycle.

Miller STR 500 DC is an electronically controlled stick electrode power source. This power source features Lift-arc TIG, gouging and remote control options.

Applications include; superior performance in maintenance, pipe welding and building applications.

Package includes:

- Miller STR 500 DC CC power source
- Power source supplied with running gear

Optional equipment:

- Earth clamp and welding cable
- Electrode holder and welding cable

# Multiprocess Power Sources



Miller XMT 350 DC CC/CV Power Source

Item Number

W034305

Auto-line 208 – 575 VAC  $\pm 10\%$ , 50/60 Hz. Rated at 350 A, 60% duty cycle.

This power source features multiprocess selection. By simply changing accessories an operator can select between the MMA, MIG, FCAW, MCAW and TIG processes. Miller XMT 350 comes standard with wind tunnel technology, adaptive hot start and line voltage compensation. Auto-line is a standard feature on the XMT 350 that allows input voltage selection from single- to three-phase power supplies.

Applications include; petrochemical, construction, shipbuilding, railroad, truck/trailer manufacturing, fabrication and power generation plants.

Package includes:

- Miller XMT 350 DC CC/CV power source



Miller XMT 350 MPa CC/CV Power Source

Item Number

W035350

Auto-line 208 – 575 VAC  $\pm 10\%$ , 50/60 Hz. Rated at 350 A, 60% duty cycle, 300 A, 100% duty cycle.

This power source features multi-process selection. Processes include MIG, pulsed MIG, Stick, TIG (DC-lift), flux cored, air carbon arc cutting and gouging (CAG-A). Auto-line power management technology allows for any input voltage hook-up (208 – 575 V). 115 VAC auxiliary power provides 10 A of circuit-breaker-protected power for water circulations, etc.

Package includes:

- Miller XMT 350 MPa CC/CV power source W/aux power
- Miller S-74 MPa Plus Wire Feeder (no euro adapter)
- Extension cable 24 VAC 14 pin 25 ft (7,6 m)
- 1,2 mm V-Groove drive roll kit X 1
- 1,2 mm U-Groove drive roll kit X 1

## Miller Dimension Rectifier Series

The Miller Dimension series features rugged multiprocess power sources capable of producing welds with the MIG, FCAW, MCAW, scratch-start TIG and MMA processes with the addition of the air carbon arc gouging process. Power sources come standard with hot start and line voltage compensation.

The Afrox range comprises three models; Miller Dimension 562, Miller Dimension 812 and the Miller Dimension 1250.

Applications include; fabrication and construction, heavy manufacturing, maintenance, repair, pressure vessel fabrication, pipe welding, shipbuilding and earth-moving equipment manufacturing.



### Miller Dimension 650 Power Source

Item Number

W052650

Dimension 650; 650 A at 44 VDC, 100% duty cycle, three-phase power 380/460 V, 50/60 Hz power source only.

An unbeatable combination of durability, output, efficiency and capability — all in a smaller, easier-to-handle package. Inside its tough, corrosion-resistant, all-aluminum case is big power for heavy welding jobs and carbon arc gouging. In addition to excellent stick and Lift-Arc™ TIG, the Dimension 650 also has excellent short-arc MIG characteristics for precise thin metal welding performance.

Remote control of the power source without a cord. ArcReach® technology uses the existing weld cable to communicate welding control information between the feeder or remote and power source. This technology eliminates the need for control cords, and their associated problems and costs.



### Miller SubArc DC 1250 Digital

Item Number

W034983

Available on request:

- Three-phase 380 V, 1 000 A, 100% duty cycle

Processes:

- Submerged arc (SAW)
- Electro slag (ESW)
- Air carbon arc cutting and gouging (CAC-A)

Heavy industrial applications include railcar, shipbuilding, heavy fabrication, pipe manufacturing and pressure vessels.

Optional extras:

- W054024 Locally manufactured undergear
- W054025 Locally manufactured cylinder and vertical cooler rack
- W054026 Locally manufactured single cylinder rack

# Engine Driven Power Sources



Miller Blue Star 185 DC CC Power Source

Item Number

W052185

Petrol engine driven power source. Rated at 185 A, 20% duty cycle. Auxiliary voltage 230 VAC, 7,5 kVA peak and 5,5 kVA continuous output, 50 Hz.

Miller Blue Star 185 is a DC petrol engine driven welding power source capable of producing welds with the MMA and scratch-TIG process.

Applications include; maintenance, repair, farm applications, construction and as a stand-alone generator.

Package includes:

- Miller Blue Star 185 DC CC engine driven power source
- Power source supplied with 230 VAC auxiliary plug

Optional extras:

- Miller Running Gear #301246
- Miller Lifting Eye #195353
- Miller Protective Cover #301245
- Miller Spectrum 375 X-TREME #907529

Above available on request from Afox Service Engineering Department (SED)

## Miller Bobcat 260 Series Engine Driven Power Sources



Miller Bobcat 260 Petrol CC/AC CC/DC CV/DC Power Source

Item Number

W052250

The Bobcat 260 series features rugged multiprocess engine driven power sources capable of producing welds with stick (SMAW), MIG (GMAW)\*, flux-cored (FCAW)\*, DC TIG (GTAW), non-critical AC TIG (GTAW), air carbon arc (CAC-A) cutting and gouging (3/16 in. carbons), air plasma cutting and gouging with optional Spectrum® models. \*With wire feeder.

Applications include; maintenance, repair, work trucks, farm applications, fabrication, structural steel work and as a stand-alone generator.

CC/AC - Stick/TIG, 40-260 A, 225 A at 25 V, 100% duty cycle/260 A at 25 V, 60% duty cycle  
 CC/DC - Stick/TIG1, 40-260 A, 260 A at 25 V, 100% duty cycle  
 CV/DC - MIG/FCAW, 17-28 V, 0 A at 28 V, 100% duty cycle/  
 275 A at 25 V, 60% duty cycle

Package includes:

- Miller Bobcat 260 Petrol CC/AC CC/DC CV/DC engine driven power source

Optional extras:

- Locally manufactured 2-wheel trailer (W052082)

## Miller Big Blue Series Engine Driven Power Sources

The Miller Big Blue series features rugged diesel engine driven power sources capable of producing welds with the MMA, TIG and FCAW processes with the addition of the air carbon arc gouging process.

The Afrox range comprises three models; Miller Big Blue 400 X, Miller Big Blue 500 X and the Miller Big Blue 600 X power sources.

Applications include; maintenance, repair, farm applications, construction and as a stand-alone generator.



### Miller Big Blue 400X PRO

Item Number	W052400
-------------	---------

Diesel engine driven welder. Rated at 400 A at 24 VDC, 100% duty cycle. Low OCV Stick (VRD) reduces the open-circuit voltage to 15 V when the power source is not in use. Auxiliary voltage 230 VAC, 12 kVA peak and 10 kVA continuous output, 50 Hz

Package includes:

- Miller Big Blue 400 X CC/CV engine driven power source



### Miller Big Blue 500 X CC Power Source

Item Number	W052500
-------------	---------

Diesel engine driven power source. Rated at 500 A, 40% duty cycle CC/DC. Auxiliary voltage 230 VAC, 5,5 kVA peak and 4 kVA continuous output, 50 Hz

Package includes:

- Miller Big Blue 500 X CC engine driven power source

### Miller Big Blue 600 X CC Power Source

Item Number	W052601
-------------	---------

Diesel engine driven power source. Rated at 600 A, 40% duty cycle CC/DC. Auxiliary voltage 230 VAC, 5,5 kVA peak and 4 kVA continuous output, 50 Hz

Package includes:

- Miller Big Blue 600 CX CC engine driven power source



Optional extra:

- Locally manufactured trailer (W052086)



Miller Big Blue 800 X Duo Air Pak

Item Number

W052090

Diesel engine driven welder. Rated at 800 A, 38 V, 100% duty cycle paralleled (combined). Rated at 400 A, 36 V CC/DC, 34 V CV/DC, 100% duty cycle, separate (dual outputs).

Generator power output:

- Three-phase: 27 kVA peak and 20 kVA continuous
- Single-phase: 15 kVA peak and 12 kVA peak and 12 kVA continuous

The most powerful line-up of diesel welder/generator in the industry. Ideal for dual-operator applications on labour intensive jobsites or jobsites with limited space. All-in-one welder/generator eliminates the need for an auxiliary air compressor. The industrial Ingersoll Rand screw-type air compressor is ideal for gouging and running pneumatic tools. International model comes with 400 volt three-phase power ArcReach® and vandalism lockout kit.

Optional extras:

- Miller supplied or locally manufactured trailer
- Miller Suitcase Wire Feeders
- Miller Dynasty 210 Series
- Miller Spectrum 375 X-TREME
- Miller Spectrum 875 X-TREME
- Stick/TIG Remote Controls

Accessories available from Afrox Service Engineering Department (SED)



Miller Trailblazer® 325D

Item Number

W052325

Output range DC stick 20–325 A MIG/flux-cored 15–40 V DC TIG 20–325 A.

Trailblazer® welder/generators deliver unbeatable arc performance providing the smoothest, most stable arc in the industry. The Trailblazer® exclusive technologies – Auto-Speed™ and optional Excel™ power – deliver superior runtimes, increased fuel efficiency, and improved welder/generator performance. No other compact machine in the 300-amp class delivers more welding power or more auxiliary power with better fuel efficiency and less noise — for productive, profitable, quieter jobsites.

# Miller Spectrum Plasma Cutting Power Sources

---



Miller Spectrum 375 120-240 VAC

Item Number

W006001



Miller Spectrum 875 Auto-line 208-575 V

Item Number

W006002

# Genuine Miller Accessories

## Miller Wire Feeders



### Miller Wire S-74S Wire Feeder

Item Number	W034070
-------------	---------

70 Series, S-74 S Wire Feeder 4-Roll has input power of 24 VAC, 10 A, 50/60 Hz. 3m 14 pin interconnecting cord for connecting to any Miller 14 pin power source. Interconnecting cord is attached internally to wire feeder.

Drive rolls and drive roll kits sold separately.

S - 74 MPa Plus, dual feeders available on request.

Drive Roll Kits – S – 74 S 4-Roll Feeder

- 0,9 mm V-Groove W034228
- 1,2 mm V-Groove W034227
- 1,6 mm V-Groove W034226
- 1,2 mm U-Groove W034225
- 1,2 mm V-Knurled W034291
- 2,0 mm V-Knurled W034220
- 2,4 mm V-Knurled W034219

Drive Roll Kits – 20 Series 4-Roll Feeder including Miller MigMatic 380

- 0,9 mm V-Groove W034638
- 1,2 mm V-Groove W034639
- 1,6 mm U-Groove W034644
- 1,2 mm V-Knurled W034651
- 1,6 mm V-Knurled W034652

NB: Interkon kits made on request.

NB: All other drive roll requirements available on request from Afrox Service Engineering Department.

NB: 20 Series Wire Feeders available on request

- 22 A
- 24 A
- ST-24



### Miller ArcReach® SuitCase® 12 Roll Feeder

Item Number	W034012
-------------	---------

Voltage sensing wire feeder, 14-48 VDC operating voltage.

The Suitcase wire feeder provides wire feed speed that is accurate and consistent from the start of the weld to the finish and from one weld to the next.

Plastic case design, potted PC board and double-fitted as valve ensures Suitcase withstands the harshest industrial environments. Drive rolls and drive roll kits sold separately.

Drive Roll Kits – Miller ArcReach® 12 Roll Feeder

- 1,2 mm V-Groove W034610
- 1,6 mm V-Groove W034612
- 1,2 mm U-Groove W034613
- 1,2 mm V-Knurled W034292



## Remote Controls



Miller RFCS – 14 HD Foot Control

Item Number

W030911



Miller RHC – 14 Hand Control

Item Number

W030912



Miller RCC – 14 Finger Tip Control

Item Number

W030913

Wireless remote control available on request from Afrox Service Engineering Department.



Miller Spool Gun - 220/250 DX

Spool gun with auto-detect provides reliable and economical welding of aluminium. Supplied with euro adaptor and amphenol remote plug

Item Number

W034089

## Optional Extras



Miller Coolmate 3 115 V Horizontal

Item Number

W034735



Miller Hydracool 2 115 V Horizontal

Item Number

W034093



Miller Hydracool 1 115 V Vertical

Item Number

W034733

# Afrox Voltage Reducers

VRD is an abbreviation for voltage reduction devices, or more commonly known as voltage reducers. When a VRD is fitted to a welding machine it reduces the potentially unsafe maximum OCV across the output terminals of the welding machine to a safer voltage. When attempting to strike an arc the VRD will sense this and switch the welding machine to full output whereupon normal welding can commence.

Voltage reducers are devices that are typically connected to constant current welding power sources for use with the MMA process.

It is in most cases not a requirement to fit a VRD for the TIG or MIG processes.

Voltage reducers are typically connected to the secondary (welding output) side of the power source and may be either internally or externally mounted.

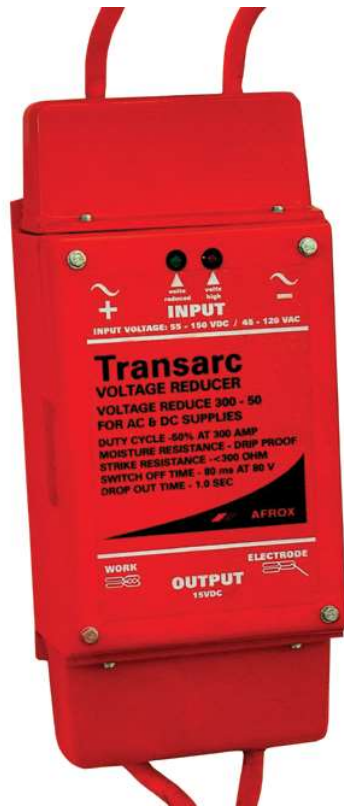

## Afrox 600 A AC/DC Voltage Reducer

Item Number W052060

Package includes:  
Afrox 600 A AC/DC Voltage Reducer

### Please note:

- Voltage reducers should only be fitted by authorised and competent personnel.
- Afrox Services Engineering Department (SED) should be consulted regarding fitment and accessories required.
- Internal voltage reducers available on request

# MIG Torches & Consumables



**MB 15 AK A/C MIG Gun 3 m**

180 A @ 60% duty cycle air-cooled

Item Number W032001



**Neck Spring MB 15**

Item Number W032013



**Shroud Taper MB 15**

Item Number W032011



**Tip Holder MB 15**

Item Number W032014



**Insulator MB 15**

Item Number W032015



**Swan Neck MB 15**

Item Number W032017



**Contact Tip**

Description	Item Number
M6 MB 15 0,6 mm	W032021
M6 MB 15 0,8 mm	W032022
M6 MB 15 1,0 mm	W032024
M6 MB 15/2 1,2 mm	W032041



### MB 25 AK A/C MIG Gun 4 m

230 A @ 60% duty cycle air-cooled

Item Number	W032003
-------------	---------



### Shroud

Description	Item Number
Conical MB 25	W032030
Taper MB 25	W032031
Cylinder MB 25	W032032



### Contact Tip

Description	Item Number
M6 0,9 mm	W032023
M6 MB 25/36 0,8 mm	W032025
MB 25/36 0,9 mm	W032026
M6 MB 25/36 1,0 mm	W032027
M6 HD M 1,0 mm	W032028
M6 MB 25/36 1,2 mm	W032029



### TIP Adaptor MB 25

Item Number	W032034
-------------	---------



### Neck Spring MB 25

Item Number	W032035
-------------	---------



### Swan Neck MB 25

Item Number	W032036
-------------	---------



### Tip

Description	Item Number
HD M6 MB 25/37 1,2 mm	W032040
HD M6 MB 25 1,0 mm	W032144
HD M6 MB 25 1,2 mm	W032145



### MB 36 KD A/C MIG Gun 4 m

300 A @ 60% duty cycle air-cooled

Item Number	W032004
-------------	---------



### Shroud Conical

Description	Item Number
Conical MB 36	W032050
Taper MB 36	W032051
Cylinder MB 36	W032052



### Tip

Description	Item Number
M8 MB 36/40/501 0,9 mm	W032042
M8 MB 36/40/501 1,0 mm	W032043
M8 MB 36/40/501 1,2 mm	W032044
M8 HD MB 36/40/5 1,2 mm	W032045
M8 HD MB 36/40/5 1,2 mm	W032046
M8 HD MB 36/40/50 1,6 mm	W032047
M8 MB 36/40/501 0,8 mm	W032146



### Tip Adaptor

Description	Item Number
M6 MB 36	W032053
M8 MB 36	W032054



### Gas Diffuser White MB 36

Item Number	W032055
-------------	---------



### Swan Neck MB 36

Item Number	W032056
-------------	---------



MB 40 KD A/C MIG Gun 4 m

380 A @ 60% duty cycle air-cooled

Item Number	W032007
-------------	---------



Gas Diffuser MB 40

Item Number	W032061
-------------	---------



Shroud

Description	Item Number
Conical MB 40	W032057
Taper MB 40	W032058
Cylinder MB 40	W032059



Swan Neck MB 40

Item Number	W032062
-------------	---------



Tip Adaptor M8 MB 40

Item Number	W032060
-------------	---------



Adaptor Block KZ-2 MB 40

Item Number	W032102
-------------	---------



Adaptor Support MB 40 &amp; R

Item Number	W032122
-------------	---------



**MB 501 D W/C MIG Gun 4 m**

500 A @ 100% duty cycle water-cooled

Item Number	W032008
-------------	---------



**Gas Diffuser White MB 501**

Item Number	W032084
-------------	---------



**Adaptor Block WZ-2 MB 501**

Item Number	W032104
-------------	---------



**Tip Adaptor M8 MB 501**

Item Number	W032085
-------------	---------



**Shroud**

Description	Item Number
Conical MB 501	W032078
Taper MB 501	W032079
Cylinder MB 501	W032080



**Insulating Washer MB 501**

Item Number	W032086
-------------	---------



**Adaptor Support MB 501**

Item Number	W032123
-------------	---------



**Swan Neck MB 501**

Item Number	W032088
-------------	---------



### RB 61 HD A/C MIG Gun 4 m

650 A @ 100% duty cycle air-cooled

Item Number W032009



### Adaptor Block RGZ-2 RB 61

Item Number W032103



### Tip Adaptor M10 RB 61

Item Number W032073



### Liner Positioner Nut RB 61

Item Number W032127



### Gas Diffuser RB 61

Item Number W032074



### Swan Neck RB 61

Item Number W032075

### Contact Tips M10 – RB61

Description	Item Number
1,2 mm HD M10	W032067
1,6 mm HD M10	W032068
2,0 mm HD M10	W032069
2,4 mm HD M10	W032070
2,8 mm HD M10	W032071
3,2 mm HD M10	W032072

### PP 36 D Straight Neck MIG Gun 8 m

300 A CO<sub>2</sub>, 270 A mixed gas 60% duty cycle

Item Number W032006

Push-Pull welding torches guarantee constant and problem free wire feeding. Push-Pull guns are ideally suited for hard to feed wire like aluminium, thin wire and for extended cable assemblies that allow welding at longer distance from the wire drive unit

Push-Pull torches have become industry standard in shipbuilding, container and tank manufacture and used extensively in the construction of automobiles, railroad cars and rolling stock



Please note: Bernard® MIG guns available on request from Afrox Service Engineering Department.



# General Consumables - MIG Torches

Product	Size	Item Number
Liner Nut		W032020
Plain Liner	1,6 - 2,4 mm 4,0 m	W032076
Plain Liner	2,8 - 3,2 mm	W032077
Liner Blue	0,8 - 0,9 mm 4,0 m	W032018
Liner Red	1,0 - 1,2 mm 4,0 m	W032037
Liner Red	1,0 - 1,2 mm 5,0 m	W032038
Liner Yellow	1,6 mm 5,0 m	W032063
Steel Liner	1,0 - 1,2 mm	W032097
Steel Liner	1,6 mm 4,0 m	W032098
Steel Liner	1,0 - 1,2 mm	W032099
Carbon Teflon Liner	1,6 mm	W032133
Liner Teflon	1,0 - 1,2 mm	W032019
Liner Teflon	1,0 - 1,2 mm	W032039
Liner Teflon	1,6 mm 5,0 m	W032064

Product	Item Number
Plate, Feed Assy	W032039
O-Ring 4XI	W032129
Trigger 2POL	W032126
Ergonomic Handle	W032124
Industrial Handle Complete	W032125
Adaptor Block KZ-2	W032101
Adaptor Support MB 15 - 18	W032121
Shroud Conical MB 15	W032012
Power Cable 3 m MB 15	W032106
Power Cable 4 m MB 25	W032108
Power Cable 4 m MB 40	W032113
Cup Gasket	W031165
Adaptor Nut MB 36/38	W032118

# Bernard® Service Parts/Consumables

## Pipeworx

MIG Gun Part 195400 - 300 Amp 15 ft Gun (W032336)

Item	Part	Description	Item Number
1	NS-5818C	Centerfire™ Nozzle	W032305
2	T-045	Centerfire™ Contact Tip	W032211
3	DS-1	Centerfire™ Gas Diffuser	W032301
4	4523R	Insulator Cap	W032302
5	QT2-60 (N/A)	Neck	W032309
6	1840057 (N/A)	Q-Neck Cover	W032310
7	1840031	Q-Neck Insulator, Rear	W032308
8	QJL-3545	Jump Liner	W032208
9	L3B-15	Liner	W032304
10	22001351 (N/A)	Power Pin Tip	W032307
11	079974	O-Ring 500 ID Rubber	W032306

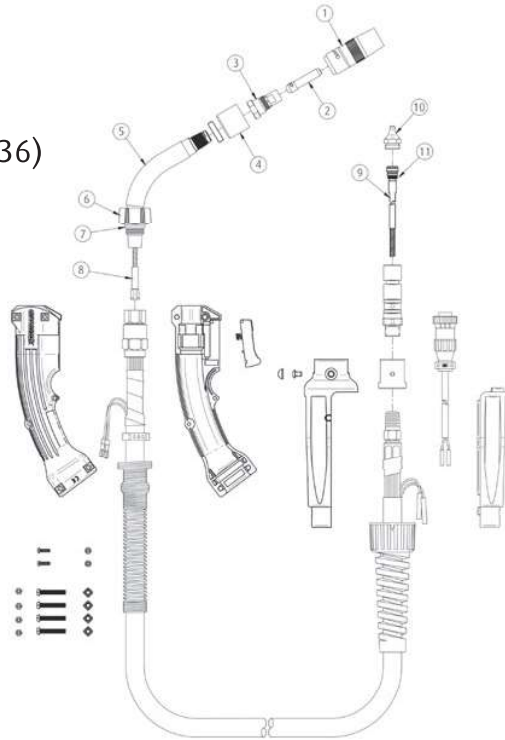

## Bernard® Dura-Flux™

with Fixed Power Cable Liner (W032336)

Item	Part #FLX3515AM	Description	Item Number
1	7010024	Insulator Tip	W032201
2	7010026	Tip Holder, Slip-On	W032202
3	T-062	Centerfire™ Contact Tip, 1/16" (1,6 mm) (Included w/Gun)	W032203
	T-078	Centerfire™ Contact Tip, 5/64" (2,0 mm) (Included w/Gun)	W032204
	T-094	Centerfire™ Contact Tip, 3/32" (2,4 mm) (Included w/Gun)	W032205
4	7010031	Neck Liner, 6" (15,2 cm)	W032226
	7010032	Neck, Liner, 12" (30,5 cm)	W032225
5	7010035	Liner, Power Pin, Miller	W032227
6	4421P	O-Ring	W032228

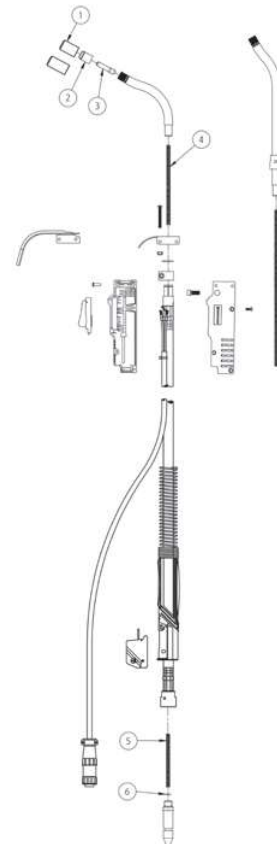

**Liners for Bernard®****200, 300, 400 & 500 Amp BTB MIG Guns**

Wire Size	Liner Color	10' (3,05 m)	15' (4,57 m)	Item Number
.035-.045	White	L3A-10*1 (N/A)	L3A-15*	W032207
.045-1/16	Red	L4A-10**1 (N/A)	L4A-15**	W032224
5/64	Blue	-	L6A-15	W032231

**Centerfire™ Consumable Series****for 200, 300, 400 & 500 Amp BTB MIG Guns****Small Centerfire™ Gas Diffusers and Nozzles**

Item	Description	Item Number
T-039	.039" (1,0 mm)	W032210
T-045	.045" (1,2 mm)	W032211
T-052	.052" (1,4 mm)	W032221
T-062	1/16" (1,6 mm)	W032203
T-078	5/64" (2,0 mm)	W032204
T-094	3/32" (2,4 mm)	W032205
T-109	7/64" (2,8 mm)	W032229
T-125	1/8" (3,2 mm)	W032230

**Large Centerfire™ Gas Diffusers and Nozzles**

Item	Description	Item Number
TT-045	.045" (1,2 mm)	W032209
TT-052	.052" (1,4 mm)	W032223
TT-062	1/16" (1,6 mm)	W032222

# TIG Torches & Consumables



W031182



W031261/ W031262



W031263/W031264

Product	Description	Item Number
TWP 17V-12-2 CK 150 A 3,8 m	150 A @ 100% duty cycle air-cooled	W031171
TWP 18-25 CK 350 A 7,6 m	350 A @ 100% duty cycle water-cooled	W031182
TWP 26-12-2 CK 200 A 3,8 m	200 A @ 100% duty cycle air-cooled	W031261
TWP 26-25-2 CK 200 A 7,6 m	200 A @ 100% duty cycle air-cooled	W031262
TWP 26V-12-2 CK 200 A 3,8 m	200 A @ 100% duty cycle air-cooled	W031263
TWP 26V-25-2 CK 200 A 7,6 m	200 A @ 100% duty cycle air-cooled	W031264

## Torch Body

Description	Item Number
TWP 17V	W031172
26V	W031178
26	W031180
TWP 18	W031183

## TIG Remote (Amperage) Controls

Description	Item Number
Miller RFCS-14 Pin Foot Control	W030911
Miller RHC-14 Pin Hand Control	W030912
Miller RCC-14 Pin Finger Tip Control	W030913



RFCS – 14 HD Foot Control



RHC – 14 Hand Control



RCC – 14 Finger Tip Control



Please note: Weldcraft TIG torches and accessories available on request from Afrox Service Engineering Department.

Product	Size (mm)	Item Number
Collet Body	1,6	W031155
Collet Body	2,4	W031156
Collet Body	3,2	W031157

Product	Size (mm)	Item Number
Collet	1,6	W031151
Collet	2,4	W031152
Collet	3,2	W031153
Collet	4,0	W031154

Product	Size (mm)	Item Number
Nozzle	8,0	W031159
Nozzle	10,0	W031160
Nozzle	11,0	W031161
Nozzle	12,5	W031162



Back Cap Long

Item Number W031163



Back Cap Short

Item Number W031164

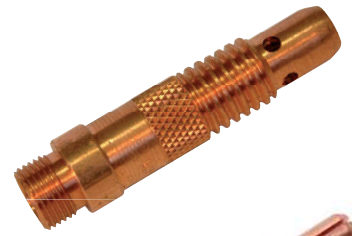

Adaptor Power Cable

Item Number W031166



Valve 26 V

Item Number W031267

### 3 Series Gas Saver Torch

Size (mm)	Product	Item Number
	Gas Saver Collet Body	W031270
	Cup Gasket Gas Saver	W031169
	Back Cap Short	W031164
	Back Cap Long	W031165
	Valve 26 V	W031267
10,0	Gas Saver Nozzle	W031258
11,0	Gas Saver Nozzle	W031259
1,6	Wedge Collet	W031174
2,4	Wedge Collet	W031175
1,6	Gas Screen	W031271
2,4	Gas Screen	W031272

### 3 Series Gas Lens Torch

Product	Item Number
Cup Gasket Gas Saver	W031169
Heat Shield Gas Lens	W031173
Back Cap Short	W031164
Back Cap Long	W031165
Valve 26 V	W031267

# New GYS Plasma Cutting Range

Afrox brings to South Africa a world class product with features and benefits that set global standards. We have the pleasure to introduce our new plasma range fit for any market and sector in South Africa with tough, rigid, durability and quality in mind.

## Plasma Power Sources



### Plasma CUTTER 45 CT - With Torch

Item Number

W006050

The CUTTER 45 CT is a 45 A plasma cutter equipped with the TPT 40 torch as standard. It offers a clean cutting capacity of 15 mm thick on a multitude of materials. The HF-free arcing system preserves and increases the lifetime of consumables. Designed to be used in difficult environments, it has a very robust mechanics and a user-friendly control panel.

#### Maximum Productivity

- Faster cutting speed using oxygas
- Cuts all types of steel (mild, stainless, tempered, HLE), aluminium, copper, etc.
- Optimised cooling using the ventilation corridor that helps insulating the electronic components from the dust
- Consumables setting up is easy for maximum productivity
- Duty cycle 41 A at 60% (40°C).
- Flexible voltage hose (85 to 265V), accepts very long network connections (100 m)
- PFC technology, the electrical network is better exploited and allows an energy saving of 30%.

#### Effective In Every Workplace

- User friendly interface :
  - 3 working modes : plain metal sheet / open metal sheet / locked
  - manual setting of the air pressure using front screen chart
- HF-free ignition to prevent disturbances that could damage nearby electronic equipment
- Compatible with CNC kit for automatic cutting tables
- Disconnectable earth cable for easy storage and replacement.

#### Designed To Last

- Reinforced metal case and non-slip rubber pads
- IP 23 certified for external use
- Compact and portable.

#### Performances

Capacity	Max. Thickness
Separation	20 mm
Clean Cut	15 mm
Piercing	8 mm



## Plasma CUTTER 70A CT - Torch Included

Item Number

W006051

The CUTTER 70 CT is a 70 A plasma cutter with a cutting capacity of 35 mm thick on a multitude of materials. The HF-free arcing system preserves and increases the lifetime of consumables. Designed to be used in difficult environments, it has very robust mechanics and a user-friendly control panel. It is prewired for use on automatic cutting tables.

### Maximum Productivity

- Faster cutting speed using oxygas
- Cuts all types of steel (mild, stainless, tempered, HLE), aluminium, copper, etc.
- Optimised cooling using the ventilation corridor that helps isolate the electronic components from the dust
- Replacement of consumables is fast and easy for maximum productivity
- Duty cycle 70 A at 60% (40°C).

### High-Performance Torch

- Premium torch TECMO (leading supplier in Europe)
- Premium cutting quality: the torch is air cooled offering a great arc stability for all types of work
- Consumables compatible with Hypertherm
- Designed to be shock and heat resistant
- Quick connect/disconnection of the torch, no tools required for transport or maintenance
- Easy to use trigger mechanism for added comfort.

### Effective In Every Workplace

- User friendly interface :
  - 3 working modes : cutting/mesh/locked
  - manual setting of the air pressure (4,1 < 6,5 bars) using front LED Indicator
- HF-free ignition to prevent disturbances that could interfere with nearby electronic equipment
- Compatible with CNC kit for automatic cutting tables.

### Designed To Last

- Reinforced metal case and non-slip rubber pads
- IP 23 protection rated
- Compact and portable.

### Performances

Capacity	Thickness
Separation	35 mm
Clean Cut	25 mm
Piercing	15 mm
Capacity	Removal Rate
De-gouging	4,8 kg/h



## Plasma NEOCUT 125A CT - Torch Included

Item Number W006052

The NEOCUT 125 is a plasma cutter with a duty cycle of 100% at 125 A for cutting work up to 57 mm thick in industrial environments. It is equipped with an automatic air pressure management, in all modes, offering an optimum cutting quality throughout the lifespan of the consumables. Also connectable to a cutting table, its Marking mode is perfect for tracing and identifying parts.

### Synergic Air Pressure

- Automatic management of pressure and air flow independent of the torch length and the operating mode (cutting, gouging and marking)
- Optimised consumable lifespan.

### Maximum Productivity

- Duty cycle 100% at 125 A (40°C)
- Marking mode, ideal for tracing and identifying parts
- Cuts most materials (mild, stainless, tempered, HLE), aluminium, copper, etc.
- Optimised cooling design to operate in an industrial environment
- Connectable through one of the 3 optional CNC kits for use on automated cutting table
- Reinforced case IP 23.

### Simple To Use

- Ergonomic interface with OLED screen (7 languages)
- 6 working modes: Cutting, Cutting with locked trigger, Gouging, Gouging with locked trigger, Cutting of perforated sheets, Marking
- Counter to follow the wear of the consumables (nozzle and electrode)
- Pneumatic diagnosis (moisture presence test and air pressure control)
- HF-free arc ignition to prevent disturbances that could damage nearby electronic equipment
- Simplified software update via USB cable without any tools or disassembly.

### Performances

Cutting	Fe	Al/CrNi
	25 mm	25 mm
	40 mm	40 mm
	57 mm	57 mm
Gouging	Withdrawal Rate	
	12 kg/h	



# Plasma Torches & Consumables

## Handheld Torches

### MT Torches

	I (60%)	I (100%)	L (m)	Item Number
MT-70	70 A (50%)	50 A	6	W006055
MT-125	125 A	105 A	6	W006056



### Torches

	I (60%)	I (100%)	L (m)	Consumables	Item Number
TPT 40	40 A	32 A	4	Included	W006086

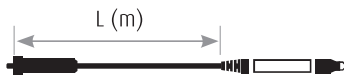

## Consumables

### Consumables

TPT 40	x1 W006088	x3 W006055	x3 W006089	x1 W006091	Box TPT 40 W006086

## Standard Consumables

### Consumables Cutting

MT-70	20-50 A 70A	W006088	W006061 W006062 (Long)	W006068 W006069 (Long)	W006075 W006078 W006079 (Long)
MT-125	45 A (Precision cut) 45 A 65 A 85 A 105 A 125 A	W006093 W006065	W006063	W006072	W006076 W006081 W006077 W006082

### Consumables Gouging

MT-70	70 A	W006088	W006061	W006070	W006075 W006080
MT-125	105 A 125 A	W006088	W006063	W006073 W006074	W006076 W006077 W006081 W006083

Boxes			
MT-70	20-70 A	Box 20-50 A W006059	-
MT-125	45-125 A	-	Box 105/125 A W006060



Compressed Air Cleaning Filter

Item Number	W006054
-------------	---------



Filter Cartridges (x 4)

Item Number	W006053
-------------	---------





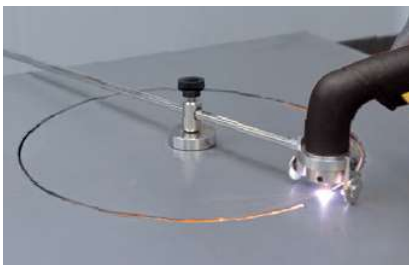

Filter Kit for CUTTER 70 / Neocut 105/125

Item Number	W006054
-------------	---------



Compass

Compass										
	Ø max	Trolley Included	Torches Compatibility							Item Number
			TPT 25	TPT 40	MT 25K	MT 35K	MT 45	MT 70	MT 125	
	1 540 mm	 W006199	.	.	.	.	.	-	-	W006087
	820 mm	 W006057	-	-	-	-	-	.	.	W006058



# Afrox Arc Equipment – RENT OR BUY?

In the construction industry, a general rule of thumb is that if you don't utilise a piece of equipment at least 60 to 70 percent of the time, you should consider renting. Afrox has partnered with Miller to offer tailor-made welding equipment rental packages to the South African market, affording customers the option to rent a selection of premium arc welding machines for

short- to medium-term projects. The Afrox equipment rental offer incorporates four models from the Miller range of premium quality welding machines for large industrial applications, and provides customers with the option of selecting equipment for various processes: MMA/Stick, TIG (DC), MIG/FCAW/MCAW and gouging.

